

KURZWEIL®

***M3/M3W***

USER'S  
MANUAL

English Manual

**HDC** YOUNG CHANG  
MUSIC

## IMPORTANT SAFETY INSTRUCTIONS

1. Read these instructions.
2. Keep these instructions.
3. Heed all warnings.
4. Follow all instructions.
5. Do not use this apparatus near water.
6. Clean only with dry cloth.
7. Do not block any of the ventilation openings. Install in accordance with the manufacturer's instructions.
8. Do not install near any heat sources such as radiators, heat registers, stoves, or other apparatus (including amplifiers) that produce heat.
9. Do not defeat the safety purpose of the polarized or grounding-type plug. A polarized plug has two blades with one wider than the other. A grounding type plug has two blades and a third grounding prong. The wide blade or the third prong is provided for your safety. If the provided plug does not fit into your outlet, consult an electrician for replacement of the obsolete outlet.
10. Protect the power cord from being walked on or pinched, particularly at plugs, convenience receptacles, and the point where they exit from the apparatus.



11. Only use attachments/accessories specified by the manufacturer.
12. Use only with a cart, stand, tripod, bracket, or table specified by the manufacturer, or sold with the apparatus. When a cart is used, use caution when moving the cart/apparatus combination to avoid injury from tip-over.
13. Unplug this apparatus during lightning storms or when unused for long periods of time.
14. Refer all servicing to qualified service personnel. Servicing is required when the apparatus has been damaged in any way, such as power-supply cord or plug is damaged, liquid has been spilled or objects have fallen into the apparatus, the apparatus has been exposed to rain or moisture, does not operate normally, or has been dropped.
15. Allow adequate ventilation for the power adapter. Do not hide it under a carpet or behind a curtain or place it in an enclosed space where heat buildup can occur.

### WARNING:

To reduce the risk of fire or electric shock, do not expose this apparatus to rain or moisture.

Do not expose this equipment to dripping or splashing and ensure that no objects filled with liquids, such as vases, are placed on the equipment.

To completely disconnect this equipment from the AC Mains, disconnect the power supply cord plug from the AC receptacle.

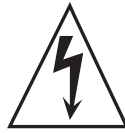
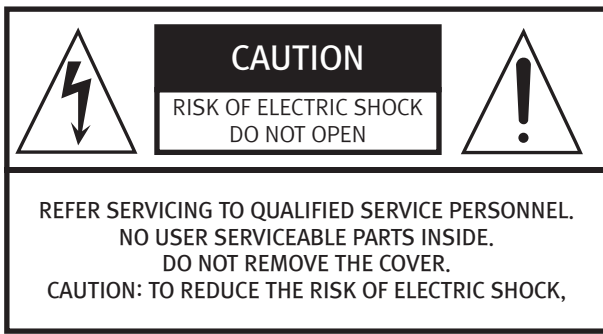

The lightning flash with the arrowhead symbol, within an equilateral triangle is intended to alert the user to the presence of uninsulated "dangerous voltage" within the product's enclosure that may be of sufficient magnitude to constitute a risk of electric shock to persons.



The exclamation point within an equilateral triangle is intended to alert the user to the presence of important operating and maintenance (servicing) instructions in the literature accompanying the product.

## IMPORTANT SAFETY & INSTALLATION INSTRUCTIONS

### INSTRUCTIONS PERTAINING TO THE RISK OF FIRE, ELECTRIC SHOCK, OR INJURY TO PERSONS

**WARNING:** When using electric products, basic precautions should always be followed, including the following:

1. Read all of the Safety and Installation Instructions and Explanation of Graphic Symbols before using the product.
2. Do not use this product near water - for example, near a bathtub, washbowl, kitchen sink, in a wet basement, or near a swimming pool, or the like.
3. This product should only be used with a stand or cart that is recommended by the manufacturer.
4. This product, either alone or in combination with an amplifier and speakers or headphones, may be capable of producing sound levels that could cause permanent hearing loss. Do not operate for a long period of time at a high volume level or at a level that is uncomfortable.  
If you experience any hearing loss or ringing in the ears, you should consult an audiologist.
5. This product should be located so that its location or position does not interfere with its proper ventilation.
6. This product should be located away from heat sources such as radiators, heat registers, or other products that produce heat.
7. This product should be connected to a power supply only of the type described in the operating instructions or as marked on the product.
8. This product may be equipped with a polarized line plug (one blade wider than the other). This is a safety feature.

If you are unable to insert the plug into the outlet, contact an electrician to replace your obsolete outlet. Do not defeat the safety purpose of the plug.

9. The power supply cord of the product should be unplugged from the outlet when left unused for a long period of time. When unplugging the power supply cord, do not pull on the cord, but grasp it by the plug.
10. Care should be taken so that objects do not fall and liquids are not spilled into the enclosure through openings.
11. The product should be serviced by qualified service personnel when:
  - A. The power supply cord or the plug has been damaged;
  - B. Objects have fallen, or liquid has been spilled into the product;
  - C. The product has been exposed to rain;
  - D. The product does not appear to be operating normally or exhibits a marked change in performance;
  - E. The product has been dropped, or the enclosure damaged.
12. Do not attempt to service the product beyond that described in the user maintenance instructions. All other servicing should be referred to qualified service personnel.
13. **WARNING:** Do not place objects on the product's power supply cord, or place the product in a position where anyone could trip over, walk on, or roll anything over cords of any type. Do not allow the product to rest on or be installed over cords of any type. Improper installations of this type create the possibility of a fire hazard and/or personal injury.

## RADIO AND TELEVISION INTERFERENCE

**WARNING:** Changes or modifications to the instrument not expressly approved by Kurzweil could void your authority to operate the instrument.

**IMPORTANT:** When connecting this product to accessories and/or other equipment use only high quality shielded cables.

**NOTE:** This instrument has been tested and found to comply with the limits for a Class B digital device, pursuant to Part 15 of the FCC Rules. These limits are designed to provide reasonable protection against harmful interference in a residential installation. This instrument generates, uses, and can radiate radio frequency energy and, if not installed and used in accordance with the instructions, may cause harmful interference to radio communications. However, there is no guarantee that interference will not occur in a particular installation. If this instrument does cause harmful interference to radio or television reception, which can be determined by turning the instrument off and on, the user is encouraged to try to correct the interference by one or more of the following measures:

- Reorient or relocate the receiving antenna.
- Increase the separation between the instrument and the receiver.

- Connect the instrument into an outlet on a circuit other than the one to which the receiver is connected.
- If necessary consult your dealer or an experienced radio/television technician for additional suggestions.

The normal function of this product may be disturbed by strong electro magnetic interference. If so, simply reset the product to resume normal operation by following the instruction manual. In case the function could not resume, please use the product in another location.

**NOTICE:** This apparatus does not exceed the Class B limits for radio noise emissions from digital apparatus set out in the Radio Interference Regulations of the Canadian Department of Communications.

**AVIS:** Le présent appareil numérique n'émet pas de bruits radioélectriques dépassant les limites applicables aux appareils numériques de la class B prescrites dans le Règlement sur le brouillage radioélectrique édicté par le ministère des Communications du Canada.

## SAVE THESE INSTRUCTIONS

Chapter 1	<b>Introduction</b>	
	Main Features -----	3
Chapter 2	<b>Preparation</b>	
	Piano Assembly -----	4
Chapter 3	<b>Getting Started</b>	
	Overview -----	8
	Basic Operation -----	11
	Quick Start -----	11
Chapter 4	<b>Using</b>	
	Voice Mode -----	14
	Rhythm Mode -----	15
	Split Mode -----	16
	Layering -----	17
Chapter 5	<b>Getting the Most</b>	
	Transpose Mode -----	18
	Touch Sensitivity -----	18
	Function Mode -----	19
	Recording a Song -----	20
	Using the MIDI -----	22
Chapter 6	<b>Appendix</b>	
	MIDI Implementation Chart -----	23
	Voice List -----	24
	Rhythm Patterns -----	26
	M3/M3W Features -----	27

Congratulations on your purchase of a Kurzweil Digital Piano.

You are certain to enjoy many hours exploring the variety of features as well as the beautiful preset voices.

This Digital Piano is designed with the same sound technology found in the world acclaimed PC3 Series keyboard.

We recommend that you read this manual carefully so that you can take full advantage of the advanced and convenient functions of the KURZWEIL Digital Piano.

## **Main Features**

---

- 88-Note, Fully-Weighted, Graded Hammer-Action Keyboard
- 200 Preset Voices
- 100 Preset Rhythm Patterns
- 10 Drum Kits
- Scrolling alphanumeric LED display
- Layering, Split, Transpose, Pitch Tuning
- Variation, Metronome, and Tempo buttons
- 4 User "Favorites" presets
- 10 Levels of keyboard sensitivity
- Two track recording with 20 User song presets
- Dedicated button to select the Grand Piano voice
- Preset Effects including Reverberation, Echo, Delay, Chorus, and Distortion
- 51 Built In Demo Songs
- Stereo Audio Input and Output Jacks
- 2 Headphone jacks
- Standard MIDI In and Out
- USB "Plug & Play" Computer port
- MIDI file compatibility
- Matching Bench Included

## Piano Assembly

### Names of Parts

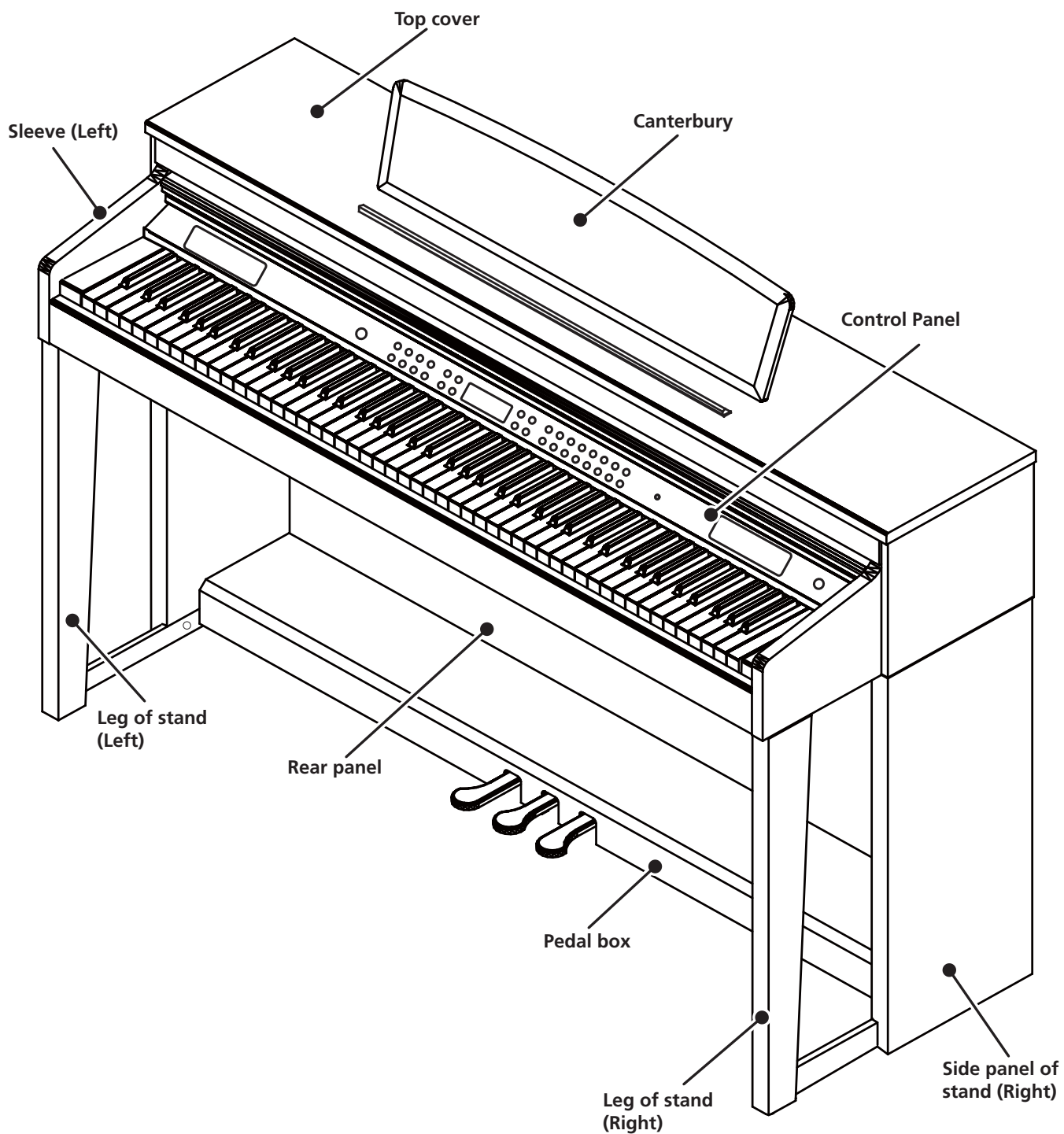

## Components

- Check that all of the following items are present.

❶ Keyboard	1 EA	❹ Screw for side panel and keyboard	4 EA
❷ Side panel of stand (Left)	1 EA	❺ Screw for side panel and pedal box	4 EA
❸ Side panel of stand (Right)	1 EA	❻ Screw for side panel and rear panel	2 EA
❹ Pedal box	1 EA	❼ Screw for rear/side panel, keyboard and pedal box	6 EA
❺ Rear panel	1 EA	❽ Cable clamp	2 EA
		❾ Prop for pedal box	2 EA

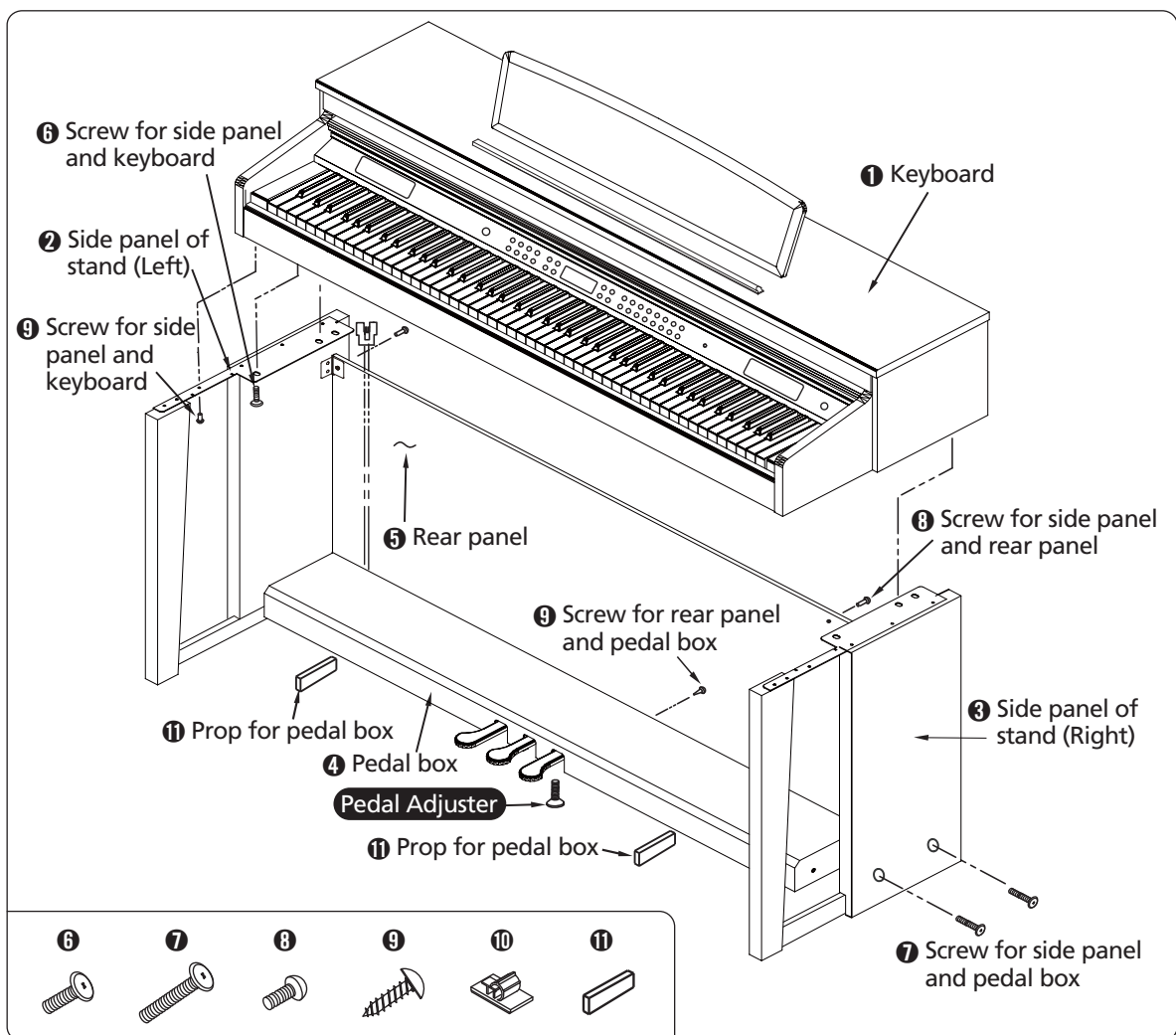

## Accessories

AC adaptor

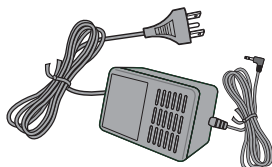

User manual

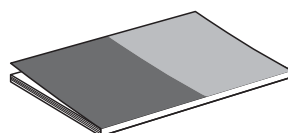

## Piano Assembly

### Stand Assembly



- Assembly should be carried out by at least two persons.
- Assemble the stand on a hard and flat floor with ample space.
- Be sure to use the included screws, and insert screws of the correct size in the correct hole locations. Use of incorrect screws can damage the product.

### Side panel and Pedal box assembly

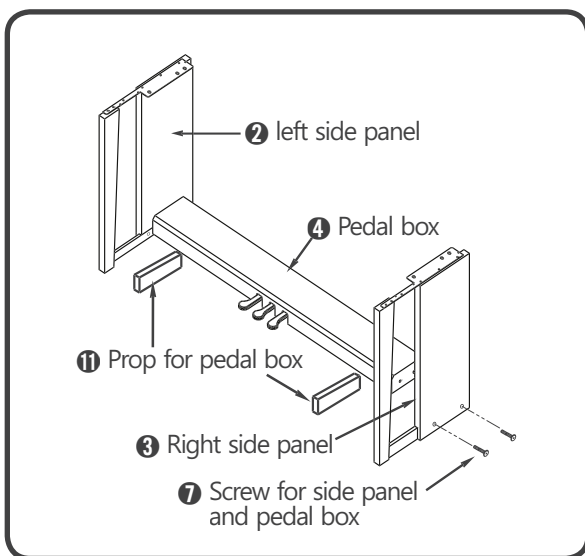

- 1 Place the 4 pedal box on the 2 left side panel using the 11 prop and use screws to fasten the side panel.
- 2 Place the 4 pedal box on the 3 right side panel and use 7 screws to fasten the side panel.
- 3 You can find the pedal cable in the 4 pedal box. Untie and straighten out the bundled pedal cable.

### Rear panel and Side panel assembly

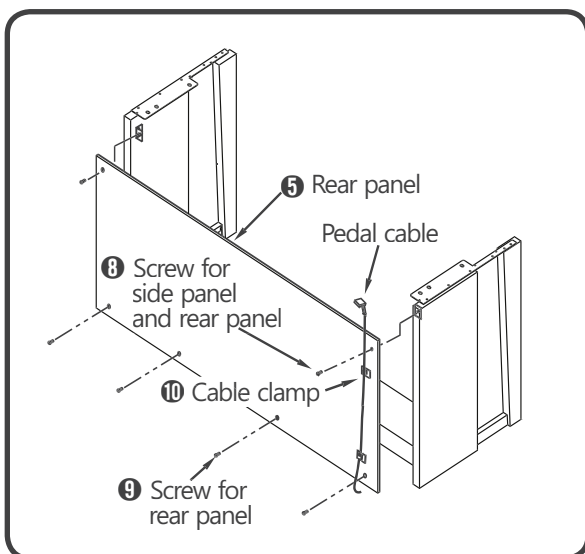

- 1 Align the 5 rear panel's holes with the side panel brackets and then use the 8 screws to fasten the rear panel.
- 2 Use the 9 screws to fasten the bottom of the rear panel.
- 3 Attach the 10 cable clamps to the rear panel as shown, then clip the pedal cable into the clamps.



## Piano Assembly

### Mounting the Keyboard

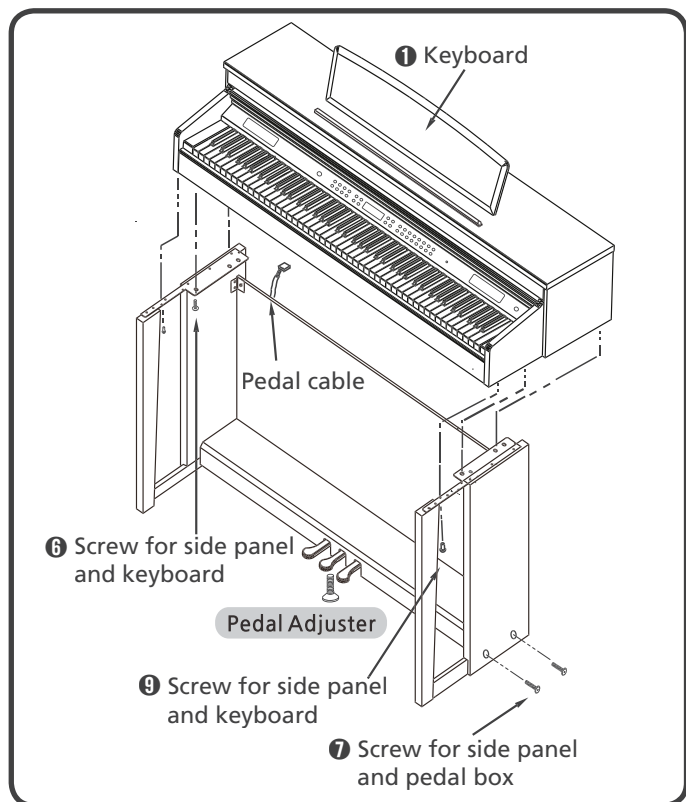

- 1 Place the 1 keyboard on the stand and align with the holes in the side panel brackets.
- ▲ WARNING**
- The keyboard assembly will not safely sit unsupported on the legs until all of the screws are in place. Have someone hold the keyboard assembly while the screws are being secured.
- 2 Fasten the keyboard to the side panel using the 6 screws.
  - 3 Fasten the 1 keyboard to the front legs using the 6 screws.
  - 4 Insert the pedal cable plug into the pedal jack located on the bottom of the keyboard.

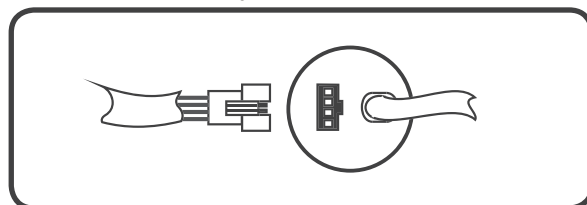

- 5 Rotate the pedal adjuster until it comes in firm contact with the floor surface.
- If the adjuster is not in firm contact with the floor, the pedals will wobble and may malfunction.

### Connecting the Power Supply

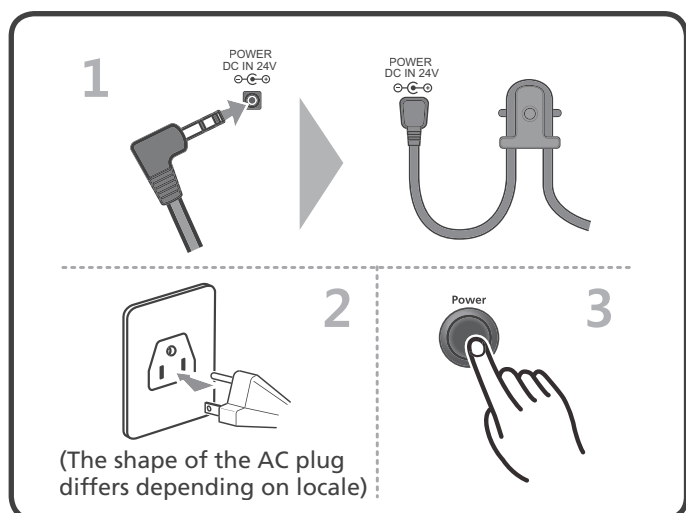

- 1 Plug the thin DC power cord into the DC Power Jack on the back of the M3 digital piano.
- ▲ CAUTION**
- All DC power adapters are NOT the same!**
- Only use the DC power adapter supplied with the M3 digital piano. Connecting the wrong DC power adapter could damage the M3 digital piano.
  - If the power adapter is damaged or lost, contact your Kurzweil Dealer to order a replacement.
- Before connecting the M3 digital piano's power adapter,**
- Make sure that the **Power** switch (located on the bottom right corner of the instrument) is in the off position.
- 2 Insert the plug of the AC power cord into the AC connector on the Adaptor, then plug the other end of the cord into the proper AC outlet on the wall. In some areas a plug adaptor may be provided to match the pin configuration of the AC wall outlets in your area.
  - 3 Press the **Power** switch located on the right of the front panel to turn the power on.

**Overview**

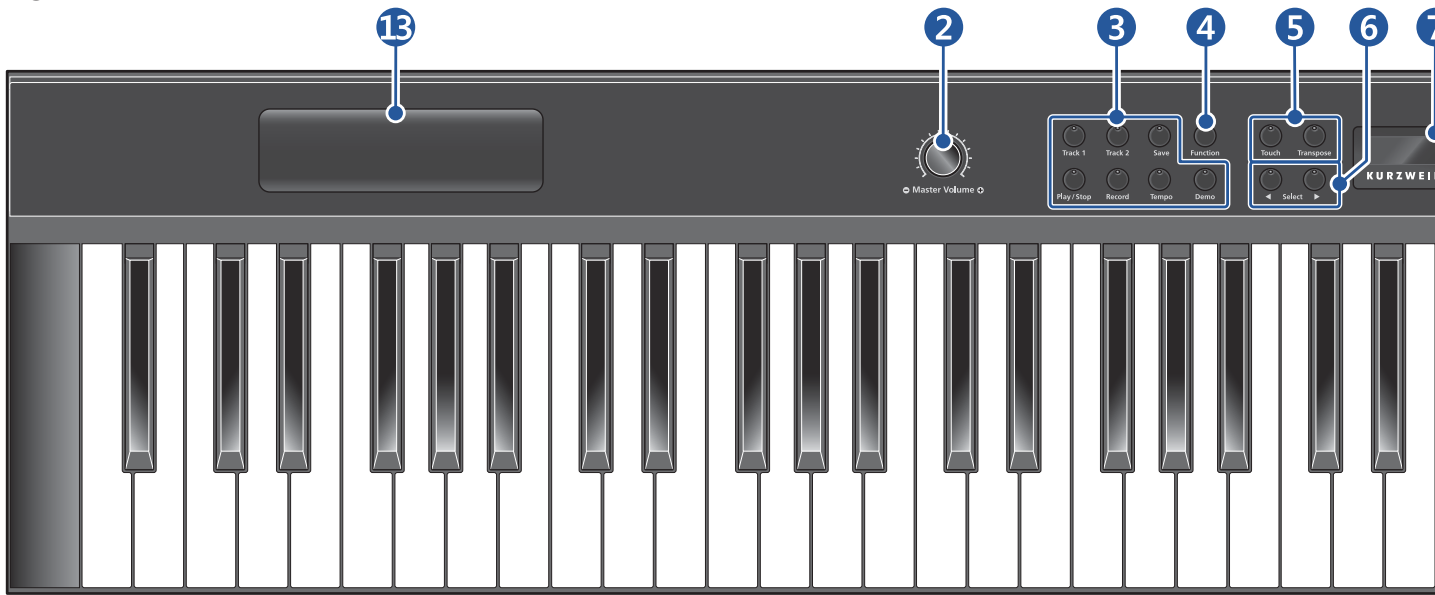

► **Front panel**

**1 Power Switch**  
**Power**



Turn the power on and off by pressing the push-button switch.

**2 Master Volume** dial



Adjusts the volume of the M3 digital piano.

**3 Play/Record section**

**3 Play/Record section**

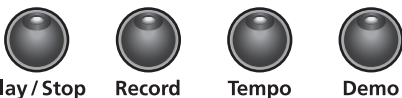

**Track 1/2 button:** Select the track to record.

**Save button:** Store the recorded song.

**Play/Stop button:** Select this button to play or stop recording, user songs, Rhythm patterns, and Demos.

**Record button:** Press this button to begin recording.

**Tempo button:** Adjust the tempo of the metronome and Rhythm patterns.

**Demo button:** Starts/ends playing the classical piano demonstration songs.

**4 Function button**



**Function**

Enter Function Mode. Many additional features are found here.

**5 Keyboard Control section**

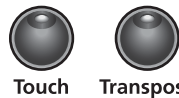

**Touch**

**Transpose**

**Touch button:** Adjust the keyboard touch sensitivity to your playing technique.

**Transpose button:** Adjust the overall pitch of the keyboard up or down in semitone intervals.

**6 Select** buttons



**Select**

Moves through the list of available parameters for the current mode.

**7 Display**



**Voice Bank 1/2**

Indicates Voice Bank 1 or 2 selection mode.

**Rhythm Bank**

Indicates the Rhythm Bank selection mode.

Scrolling alphanumeric LED display for information, condition, status or settings.

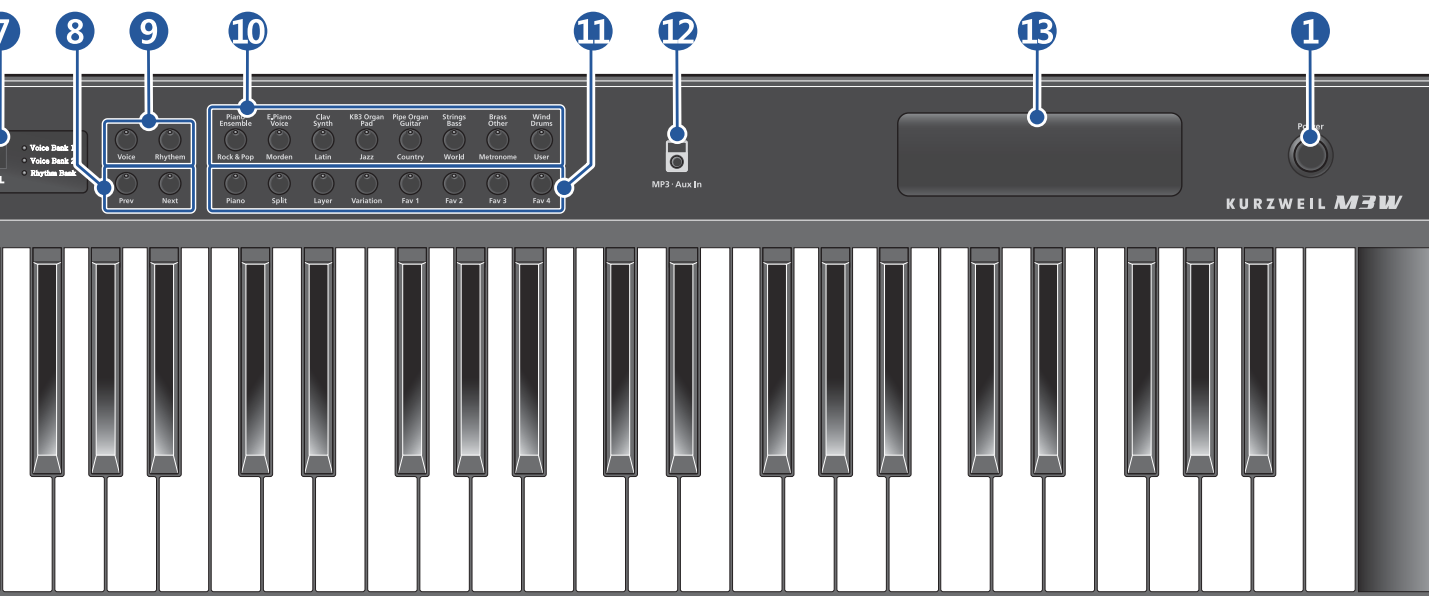

**8** Prev/Next button

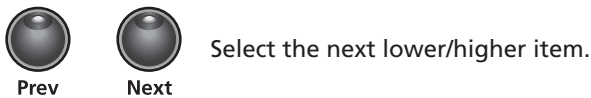

**9** Voice/Rhythm select section

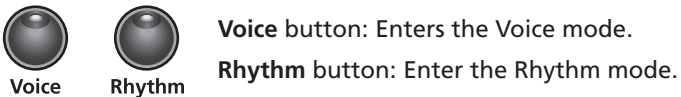

**10** Voice/Rhythm Category section

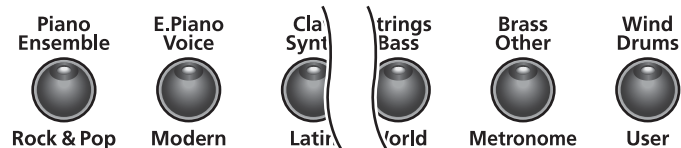

Select a voice or rhythm pattern.

**11** Performance Mode section



**Piano** button: Return to the Grand Piano voice (the first voice of the Piano category).

**Split** button: Enters the Split mode to create split voices.

**Layer** button: Enters the Layer mode to create 2-layered voices.

**Variation** button: Use a variation of the current voice.



**Favorites [Fav] 1/2/3/4** button: Select one of 4 previously stored favorite sounds. Press and hold to store the currently selected sound with its splits and layers.

**12** MP3•Aux In button



Connects an external audio source to the M3 sound system.

MP3 • Aux In

**13** Tweeter speakers

Part of the M3 sound system.

**Overview**

► **Headphones Jacks**

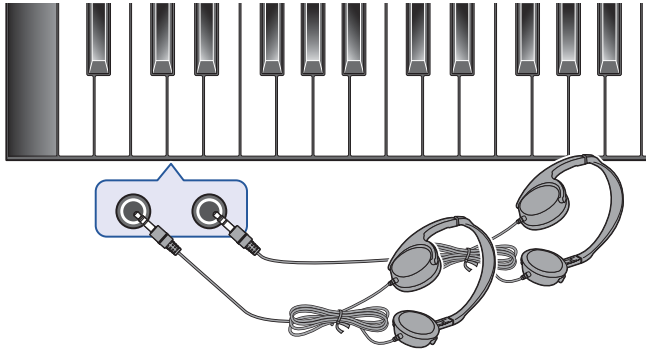

14 **Headphones 1/2 jacks**

The M3 has two 1/4" headphone jacks conveniently located on the left bottom edge of the keyboard cabinet. Plugging in headphones provides privacy during practice. Both jacks operate the same so two people can play and hear the music together.

While using headphones, the M3's speakers are silent.

▲ **CAUTION**

- Do not use headphones at a high volume for an extended time. Doing so may cause hearing loss.

► **Rear Panel**



**USB port**

Connect a USB cable to this port to send and receive MIDI or to connect to a computer for system updates.

**MIDI In & Out ports**

Use the MIDI In and Out ports to connect the M3 digital piano to other MIDI devices to receive and send MIDI data.

**Audio In terminals**

Use these RCA stereo jacks to connect the M3 digital piano's internal speakers to other devices such as a digital audio player or CD player. Always turn off the M3 digital piano's power before plugging or unplugging cables into the Audio In jacks.

**Audio Out terminals**

Use these RCA stereo jacks to connect the M3 digital piano to external audio equipment, such as an outboard mixer, powered speakers, or recording device.

**DC In terminal**

Connect the DC Adapter to this jack.

## Basic Operation

### Turning on/off

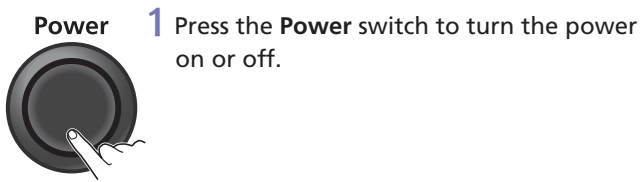

#### ▶ Before turning on/off ....

- Before turning on the M3 digital piano, it's always a good idea to set the volume at its minimum setting (all the way to the left).

### Adjusting the Volume

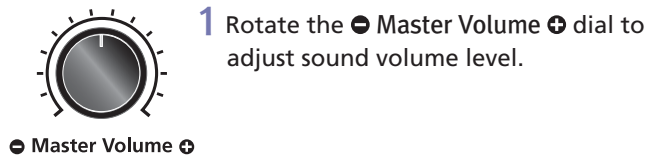

## Quick Start

### Playing the Voices

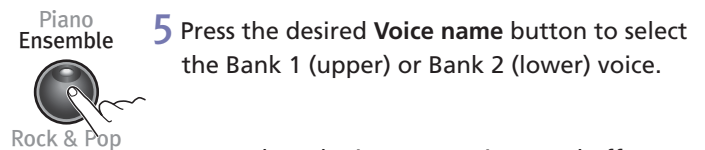
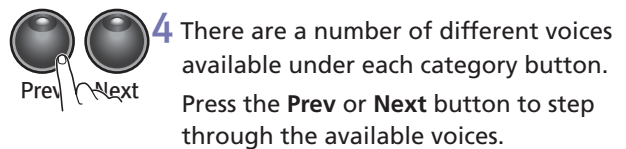
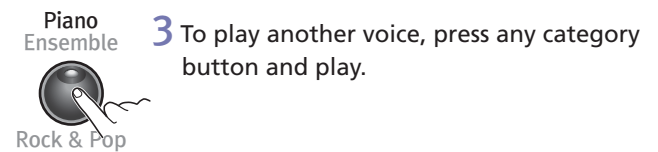
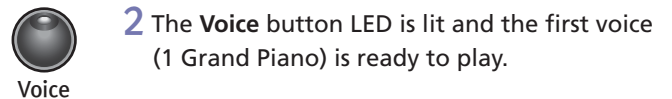

Even when the instrument is turned off, AC power is still flowing to the adapter at a minimum level. When you are not using the instrument for a long time or during electrical storms, unplug the AC power cord from the wall outlet.

## Using the Pedals

### • Soft pedal

The soft pedal reduces the volume and slightly changes the timbre of notes played while the pedal is pressed. The soft pedal will not affect notes that are already playing when it is pressed.

### • Sostenuto pedal

If you play a note or chord on the keyboard and press the sostenuto pedal while the notes are held, those notes will sustain as long as you hold the pedal (as if the damper pedal had been pressed) but all subsequently played notes will not be sustained. This makes it possible to sustain a chord, for example, while other notes are played "staccato".

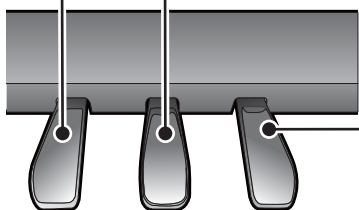









### • Sustain pedal





The sustain pedal functions in the same way as the damper pedal on an acoustic piano. When the damper pedal is pressed, notes sustain longer. Releasing the pedal immediately stops any sustained notes.

## Quick Start

### Playing a Rhythm Pattern

-  1 Press the **Rhythm** button to select the Rhythm mode.  
Rhythm
-  2 Select a Rhythm Pattern from one of the categories and press its button.  
Piano Ensemble
-  Rock & Pop
-  3 There are a number of different rhythm patterns available under each category button. Press the **Prev** or **Next** button to step through the available rhythm patterns.  
Prev Next
-  4 Press the **Play/Stop** button to start the rhythm.  
Play/Stop
-  5 Press the **Play/Stop** button again to stop it.  
Play/Stop
-  6 To change the tempo, press the **Tempo** button. Its LED lights and the display shows the current tempo. Press the **Prev** or **Next** button to decrease or increase the tempo.  
Tempo
-  Prev Next

### Playing a Demo Song

-  1 Press the **Demo** button.  
Demo
-  2 The first demo song immediately plays. The M3 continues to play each of the 51 demo songs until you press the **Play/Stop**, **Demo** or **Voice** buttons.
-  3 At any time you can press the **Play/Stop** button to start or stop playing a demo song.  
Play/Stop
-  4 Press the **Prev** or **Next** button to play the previous or next demo song. Simultaneously press the **Prev** and **Next** buttons to jump ahead 10 songs at a time.  
Prev Next
-  5 Press the **Demo** button to finish Demo Mode.  
Demo

## Demo Song List

No.	Song Name	Key	Composer
1	Rhapsody	A0	J. Brahms
2	Prelude I	A#0	J. S. Bach
3	Invention No. 4	B0	J. S. Bach
4	Invention No. 8	C1	J. S. Bach
5	Prelude II	C#1	J. S. Bach
6	Aria Goldberg	D1	J. S. Bach
7	Fuga II	D#1	J. S. Bach
8	Sonatine Op.36	E1	M. Clementi
9	Klavierstück	F1	W. A. Mozart
10	Piano Sonate	F#1	W. A. Mozart
11	Rondo in D	G1	W. A. Mozart
12	Piano Sonate K.3	G#1	W. A. Mozart
13	Piano Sonate K.5	A1	W. A. Mozart
14	Minuet in G	A#1	L. V. Beethoven
15	Bagatelle No. 25	B1	L. V. Beethoven
16	Sonatine Op.55	C2	Fr. Kuhlau
17	March Militaire	C#2	F. P. Schubert
18	Moments Musicaux	D2	F. P. Schubert
19	Impromptu No. 2	D#2	F. P. Schubert
20	Impromptu No. 4	E2	F. P. Schubert
21	La Chevaleresque	F2	J.F. Burgmüller
22	Without words	F#2	J. L. F. Mendelssohn
23	Venetianisches	G2	J. L. F. Mendelssohn
24	Sostenuto	G#2	F. F. Chopin
25	Valse KK	A2	F. F. Chopin
26	5 Mazurkas	A#2	F. F. Chopin
27	Valse Op.69 No. 2	B2	F. F. Chopin
28	Grande Valse	C3	F. F. Chopin
29	Valse Op.64 No. 2	C#3	F. F. Chopin
30	Nocturne No. 2	D3	F. F. Chopin
31	Valse Op.64 No. 1	D#3	F. F. Chopin
32	Preludes in Db	E3	F. F. Chopin
33	Fantaisie-Improm	F3	F. F. Chopin
34	Traumerei	F#3	R. Schumann
35	Fröhlicher Landma	G3	R. Schumann
36	Von fremden Land	G#3	R. Schumann
37	Liebesträume #3	A3	F. Liszt
38	Dolly's Dreaming	A#3	T. Oesten
39	Frühlingsstimmen	B3	J. Strauss
40	The Swan	C4	Saint-Saëns
41	Blumenlied	C#4	G. Lange
42	Valsette	D4	F. Borowski
43	Old French Air	D#4	P. I. Tchaikovsky
44	Mazurka	E4	P. I. Tchaikovsky
45	Polka	F4	P. I. Tchaikovsky
46	Barcarolle	F#4	P. I. Tchaikovsky
47	Humoreska	G4	A. Dvorak
48	Suite Peer Gynt	G#4	E. Grieg
49	Suite Bergamasque	A4	C. A. Debussy
50	Reverie	A#4	C. A. Debussy
51	Arabesque I	B4	C. A. Debussy

## Voice Mode



**1** Press the **Voice** button to select Voice Bank 1 or 2.

- When you turn on the M3 digital piano, Voice Mode is active and the Grand Piano voice is already selected and ready to play.
- Grand Piano is the default voice and the first voice in the Piano category.
- In Voice Mode, voices are selected first by choosing one of the two Voice Banks (upper and lower), then a category.

Piano Ensemble



Rock & Pop

**2** Press the **Category name** button for the desired voice category in the current voice bank.

There are two rows of category names (upper and lower) and one row of category name buttons. Categories generally group instruments by type.



**3** To select another voice from the category, press the **Prev** or **Next** button to navigate through the available voices.

To find the default or first voice of the current category, press the **Prev** and **Next** button pair together.

To change the Category Default Voice, press the **Save** button.

"SAVED" scrolls across the display. Your new sound is now saved as the first or Default Voice for that category.

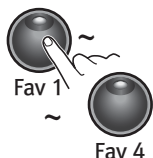

**4** You can quickly save any voice or layered voice as a favorite. Just select a voice, or layer, then press and hold one of the four Favorites buttons at least 1.5 seconds. The voice is now stored in that location.



## Rhythm Mode



1 Press the **Rhythm** button to enter Rhythm Mode.

The [Rhythm] button's LED lights up as well as the Rhythm Bank LED. The display shows the ID number of the current rhythm pattern.

- The default rhythm pattern is ID number 1, Ballad1.

Piano Ensemble



Rock & Pop

2 Press the **Category Name** button for the desired rhythm category.

- There are eight category buttons in the Rhythm Bank. The first seven buttons are for the rhythm patterns and are grouped by style. The eighth button, labeled **User**, is for user recorded songs.



3 After you select a category, press the **Prev** or **Next** button to scroll through the rhythm patterns.

- When you reach the end of a category, the MP20 automatically advances to the next or previous category. It will also advance to the User category. If there are no user recorded songs, it will bypass the User category and go to the next or previous rhythm category.

Piano Ensemble



Rock & Pop

- To find the default or first Rhythm of the current category, press the **Prev** and **Next** button pair together.

To change the Category Default Rhythm, press the **Category** button.

"SAVED" scrolls across the display. Your new pattern is now saved as the first or Default Rhythm for that category.



Play/Stop

5 To play the selected rhythm pattern, press the **Play/Stop** button.

To stop the rhythm playback, press the **Play/Stop** button.



Tempo

6 To change the tempo, press the **Tempo** button. Its LED lights and the display shows the current tempo.

Press the **Prev** or **Next** button to decrease or increase the tempo.

You can change the tempo of the M3 digital piano's rhythm patterns.

The default tempo is 120 BPM (beats per minute), but it can range from 20 to 300 BPM.

To return to the default setting of 120 BPM, press the **Prev** and **Next** buttons together.

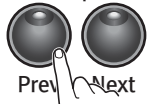

Prev Next

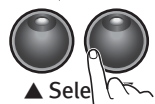

▲ Sele

7 To change the Volume of the rhythm pattern for playback or recording, press the **Select ▲/▼** button until **VOL:X** (X represents the current volume setting) is displayed. Press the **Prev** or **Next** button to raise or lower the volume.

- The volume range is from 1 (minimum) to 9 (maximum).
- The default volume setting is 9 (maximum).

To reset the volume to the default setting, press the **Prev** and **Next** buttons together simultaneously.

Changing the Tempo and Volume affects all rhythm patterns, even Favorites.

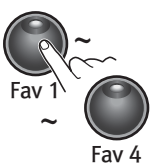

Fav 1

Fav 4

8 To save your setting, press and hold one of the Fav 1 ~ Fav 4 button at least 1.5 seconds.

Your Rhythm is now stored in that location, then select a Fav 1 ~ 4 button to store your Rhythm.

## Split Mode

Creating a Split allows you to divide the M3 keyboard into an upper and lower region.  
For example, you can create a split and play Piano with the right hand and Bass with the left hand.



- 1 Select the voice you want to use as your primary voice.  
Press the **Split** button to enter Split mode.  
When the **Split** button is pressed, the current voice becomes the primary (right hand) split voice.  
The default split (secondary) voice ID is 183, E Bass (left hand), and the default split key is F#3.



- 2 To choose a different voice as the secondary voice, select the voice category you desire, then press the **Prev** or **Next** buttons to scroll to your desired sound. The new sound will now become your default “left hand” or secondary voice.
  - Pressing the **Prev** and **Next** button pair together, will reset to the factory default voice setting.



- 3 There are two parameters available in Layer Mode. Changing the value of a parameter determines the performance of the Split. In Split Mode, use the **Select ▲/▼** Buttons to step through the parameters.
  - **Split Key [KEY: F#3 (default)]**: sets the position of the split key (highest key of the secondary voice). (range: any key from A0 to C8.)
  - **Split Volume [VOL: 0 (default)]**: sets the Split Balance Volume. [range: -9 to +9]
  - **Split Transposition [XPOSE:0 ST (default)]**: sets the transposition of the secondary voice relative to the primary voice. [range: 24 Semitones (2 octaves)]

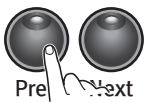

- To change the value of a parameter, press the **Prev** or **Next** button.
- Pressing the **Prev** and **Next** button pair together, will reset to the factory default setting.

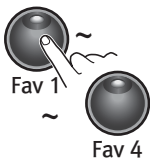

- 5 Once you have created your split setting, select a Favorite 1 ~ 4 button to store the split setting.  
Press and hold any **Fav 1** ~ **Fav 4** button for at least 1.5 seconds.  
The split setting is now stored in that location.

**NOTE:**







- Changes to the Split Voice, Split Key, Split Volume, and Split Transposition are remembered for the next time you want to use a split voice; but are not stored in memory. They return to their default settings when you turn off the M3 digital piano.
- Be sure to save your changes as one of the Favorites!

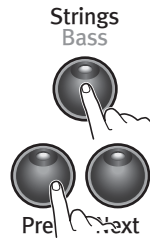

- 6 To exit Split Mode, press the **Split** button again.

## Layering

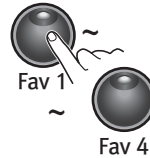
In addition to the many presets already available in the M3 digital piano, you can create layered voices and add even more depth and breadth to its rich sounds. Layering combines two of the M3 digital piano voices enabling you to play both voices together.

-  **1** Select the voice you want as your primary voice, by choosing the sound in the Category section. Scroll with the **Prev** or **Next** button if needed to find the desired sound.
-  **2** Press the **Layer** button to enter Layer Mode. When the **Layer** is activated, the current voice becomes the primary layer voice. The **Layer** button LED lights and the secondary voice of the layer scrolls across the screen. (The default is 87, LA Strings). The primary voice is now layered with the secondary voice.
  - Pressing the **Prev** and **Next** button pair together, will reset the layer balance back to factory default setting of 0.
-  **3** To change to a new secondary voice, the Voice button must be ON. Choose the category you want on Row 1 or Row 2 by toggling the Voice button to either row. Select the voice category you desire. Scroll with the **Prev** or **Next** button if needed to find your desired sound. The new sound chosen is now your secondary sound.
  - When in Layer mode, only the secondary sound can be changed. You must start with your primary sound to create your desired combination.
  - Pressing the **Prev** and **Next** button pair together, will reset the secondary sound back to default.
-  **4** There are two parameters available in Layer Mode. Changing the value of a parameter determines the performance of the layer. In Layer Mode, use the **Select ▲/▼** Buttons to step through the parameters.
  - Volume Balance [VOL: 0 (default)]**: sets the volume balance between the 2 layered sounds. (range: -9 to +9).
  - Transpose [XPOSE: 0 (default)]**: sets the transposition of the secondary voice relative to the primary voice. [range: 24 semitones (2 octaves)]To change the value of a parameter, press the **Prev** or **Next** button.
  - Pressing the **Prev** and **Next** button pair together, will reset to the factory default setting of the parameter.
-  **5** Once you have created your layered sound, select a Favorite 1 ~ 4 button to store the layered voice. Press and hold any **Fav 1** ~ **Fav 4** button for at least 1.5 seconds. The layered voice is now stored in that location.
-  **6** To exit Layer Mode, press the **Layer** button again.

## Transpose Mode

The Transpose parameter allows you to adjust the overall pitch of the keyboard up or down in semitone intervals.

- 

**1** Press the **Transpose** button to enter the Transpose mode.  
"TRANSCOPE: 0" (factory default) is displayed on the LED Screen.
- 

**2** Press the **Prev** or **Next** buttons to transpose the pitch down or up by semitones.  
The transposition has a range of -24 to +24. This offers a two octave transposition range down or up.  
• Pressing the **Prev** or **Next** button pair together, will reset the Transposition back to the factory default of 0.
- 

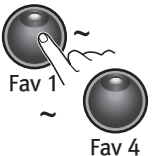
**3** Press the **Transpose** button to Exit the Transpose mode.
- 

**4** To save your transposition setting, press and hold any of the **Fav 1 ~ Fav 4** buttons.

## Touch Sensitivity

Adjust the keyboard touch sensitivity to your playing technique.

- 

**1** Press the **Touch** button to enter the Touch Sensitivity mode.  
"TOUCH: LINEAR" (factory default) is displayed on the LED Screen.
- 

**2** Press the **Prev** or **Next** button to select the desired Touch sensitivity setting.  
The following are the available settings:  
• **LINEAR**: Best Dynamic Range for instruments (Factory Default Setting).  
• **LIGHT 1/2/3**: For players with a light touch. Adjust this parameter to achieve a good dynamic range. These settings are from LIGHT 1, a slightly light touch to LIGHT 3, a very light touch.  
• **HARD 1/2/3**: For players with a heavier touch. Adjust this parameter to achieve a good dynamic range. These settings are from HARD 1, a slightly harder touch to HARD 3, a very hard touch.  
• **PIANO TOUCH**: Best for piano dynamics.  
• **EASY TOUCH**: Light touch, especially for younger players.  
• **GM RECEIVE**: Select this when playing General MIDI songs.  
• Pressing the **Prev** or **Next** button pair together will reset the Touch Ssensitivity setting back to the factory default of **LINEAR**.
- 

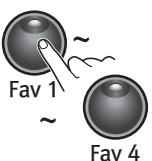
**3** Press the **Touch** button to Exit the Touch sensitivity mode.
- 

**4** To save your touch sensitivity setting, press and hold any of the **Fav 1 ~ Fav 4** buttons.

---

---

---

---

## Function Mode

The Function Mode includes parameters that allow you to change the behavior of the entire instrument. The following are available parameters in Function Mode: Effect Level, Tune, MIDI Channel, Metronome, Rec Rhythm, Local Control, Hard Reset, OS/Object. Depending on the selected parameter and the current mode, some buttons operate differently. The following is a description of the Layer Mode navigation buttons.



1 Press the **Function** button to enter Function mode.  
"EFFECT LEVEL: 20" is displayed on the LED Screen.

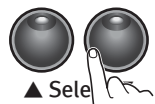

2 Pressing the **Select ▲/▼** button will take you through the various parameters mentioned below.

The following are the available settings:

- **EFFECT LEVEL:** Controls the level of the reverb effect used on a voice. [Default: 20 %, Range: 0% (no effect) to 100%]
- **TUNE:** Adjusts the fine-tuning the pitch of the entire instrument. (Default: 0 = A-440, Range: -100 ~ 0 ~ 100 cents)
- **MIDI CHANNEL:** Controls the MIDI transmit channel used for Voice Mode. (Default: CHANNEL: 1, Range: Channels 1 ~ 9 and Channels 11 ~ 15. Channel 10 is reserved for rhythm playback and Channel 16 for the metronome.)
- **METRO:** Activates/deactivates the metronome sound. [Default: OFF (no metronome), ON: metronome sounds while playing or recording, REC: hear the metronome only while recording.]
- **REC RHYTHM:** Controls whether a rhythm pattern plays during recording. (Default: OFF, ON: record a song and have the rhythm pattern recorded as well.)
- **LOCAL: ON:** This parameter is normally set to "ON". When you play the M3 keyboard you hear the resident or "LOCAL" voices. If you use your M3 digital piano with an external sequencer or computer, turn this setting to OFF. Turning the setting OFF, avoids creating a MIDI loop (stuck notes or "Echoes").
- **HARD RESET?:** Resets the M3 digital piano to the original factory default settings. All user changes, saved Favorites, and user recorded songs are erased.  
To reset to factory default, press the **Next** button once. The display now scrolls **CONFIRM?** Press the **Next** button again to confirm and reset the M3 digital piano.  
If you want to cancel the Hard Reset and remain in Function Mode, press the **Prev** button. Press any other button to exit Function Mode.
- **OS/OBJECT:** Displays the current operating software and objects version. The display first scrolls the OS version, then the Object version.  
Visit the Kurzweil website ([www.kurzweil.com](http://www.kurzweil.com)) to verify that your M3 digital piano has the latest versions. This is located under the Downloads tab for the M3 digital piano. If you wish to update, complete installation instructions are included in the downloaded files. A standard USB cable will be required for updating.



3 Once you arrive at a parameter, you will use the **Prev** or **Next** buttons to change the value of that parameter.

- Pressing the **Prev** and **Next** button pair together will reset the value back to the factory default.

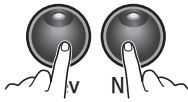

4 Pressing the **Function** button a second time will Exit.

## Recording a Song

The M3 digital piano has a two-track recorder. You can record two voice tracks and a rhythm pattern accompaniment.

Favorites can be used to give you even more versatility while recording. For example, you can have a Favorite split voice such as Piano and Bass recorded in Track 1 and a layered favorite in Track 2.

### ► Preparing to Record

- If you want to have a rhythm pattern play while recording, select the **Function** button to enter Function Mode.

Press the Select ▲/▼ buttons to step through the list of parameters. The default setting for the REC RHYTHM parameter is OFF, press the **Prev** or **Next** button to change the value to ON.

- You can leave this parameter set to ON. There is a “no rhythm” pattern available, rhythm ID number 351. Select this rhythm pattern and no rhythm will play.

#### NOTE

- The default setting for the metronome is also OFF.
- Follow the instructions described above to enter Function Mode, but select the METRO: OFF parameter and change its setting to METRO:REC. This will allow the metronome to play during recording.

### Recording Track 1



- 1 Select the voice you want to use for Track 1. To record a song with a rhythm pattern, press the **Rhythm** button and select a pattern for your recording.

Press the **Record** button.

Its LED lights and the display scrolls RECORD READY. The Track 1 button's LED should also be lit.



- 2 To begin recording, press the **Play/Stop** button and start playing.



- 3 When you are finished Recording, press the **Play/Stop** button again.

The **Save** button's LED starts flashing and the display shows SAVE SONG AS: [U1 ~ U20] (This will be the number of the first available empty user song location). There are 20 available song locations.



- 4 Press the **Save** button and Track 1 is now saved in one of the user song presets.

### Recording Track 2



- 1 Press the **Track 2** button, then the **Record** button.

The display scrolls RECORD READY message.



- 2 Press the **Play/Stop** button to begin recording Track 2.

Track 1 is plays while recording Track 2.



- 3 Press the **Play/Stop** button again when you are finished.

The Save button's LED is flashing and the display shows SAVE SONG AS Ux. (This will be the same song number as Track 1.)



- 4 Press the **Save** button and Track 2 is now saved along with Track 1 in one of the user song presets.



Simply press the **Play** button to listen to your recording.



To change to another user preset U1 ~ U20, press the **Next** button to advance to a different User Preset Number and press the **SAVE** button to store it.





---

## Finding & Editing a Song

-  1 Press the **User** Button located to the far left of the Rhythm bank.
-  2 Press the **Prev** or **Next** button to scroll through the list of User Presets (U1 – U20) to find your saved song.
-  3 Press the **Play/Stop** button to preview your saved song.  
You are now ready for editing.

---





## Erasing / Recording over Tracks

-  1 Select the user recorded song as above and press the **Track** button for the track you need to erase.
-  2 Press the **Play/Stop** button, then press the **Record** button and start playing into the track.
-  3 Press the **Play/Stop** button when you are finished.
-  4 Press the **Save** button to save the song with the new track.

---

## Punch-Ins

Punching in is a way to correct mistakes on a recording without re-recording the entire track.

-  1 Select the user recorded song and press the button for the track you need to change.
-  2 Press the **Play/Stop** button.  
Your song begins to play.
-  3 When it reaches the part you need to correct, press the **Record** button and play the note(s) you need to punch-into the recording.
-  4 After the punch-in, press the **Play/Stop** button.  
If you don't press the **Play/Stop** button after you Punch-In, you will erase the remaining portion of the track.
-  5 Press the **Save** button to save the song with the edited track.

## Using MIDI

### About MIDI

MIDI is the acronym for Musical Instrument Digital Interface. It is the industry standard protocol that allows the exchange of musical data between electronic musical instruments, devices (such as a sequencer), and computers. MIDI enables MIDI equipped devices designed by different manufacturers to communicate MIDI data to each other.

MIDI data is sent or received using standard MIDI cables to connect to other MIDI devices or a USB cable to connect to a computer.

The M3 digital piano is equipped with conventional MIDI In and Out ports and a USB port.

### MIDI Channels

Similar to television channels, MIDI protocol transmits multiple channels of MIDI performance data. Typical MIDI instruments can play up to 16 channels at the same time. Each channel can be assigned its own voice.

To change and/or assign MIDI channels, enter Function Mode and select the MIDI Channel parameter. See page 19 for the details.

### MIDI In and Out Ports

The M3 digital piano is equipped with conventional MIDI In and MIDI Out ports. If you are new to MIDI, the MIDI In port is used to receive MIDI data from another MIDI device; and the MIDI Out port is used to transmit MIDI data to another MIDI device.

When you connect the MIDI Out of the M3 digital piano to the MIDI In of another instrument, you can play the sounds of both instruments simultaneously from the M3 digital piano piano.



When you connect the MIDI In of the M3 digital piano to the MIDI Out of another controller, you can control the M3 digital piano using the other controller.



### USB MIDI Connection

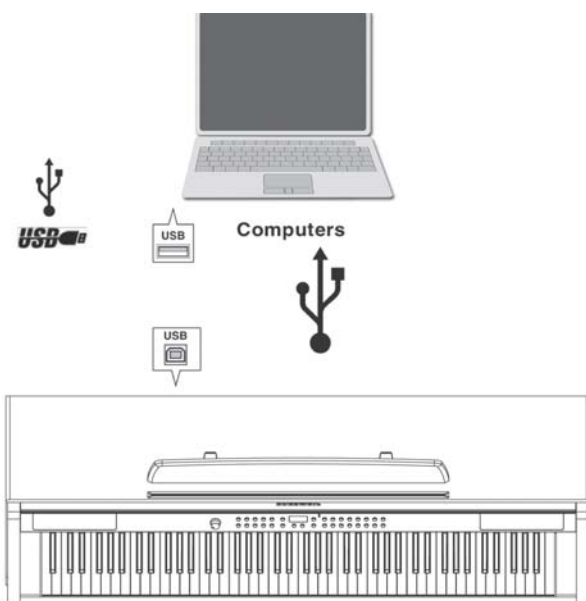

In addition to the conventional MIDI In and MIDI Out ports, the M3 digital piano also has a USB (Universal Serial Bus) port on the rear panel. You can connect the M3 digital piano directly to a computer with a USB cable. This connection transmits and receives MIDI data between the M3 digital piano and the computer.

The M3 digital piano supports the "Plug and Play" feature used in the Windows XP or higher and Macintosh operating systems. No drivers are required to use this connection; but you may need to enable MIDI on your computer's sound and audio control panel.

To use the M3 digital piano as a MIDI controller with a computer, use any Type-A to Type-B USB cable. By default, the M3 digital piano acts as a MIDI controller (not a hard drive) when connected to a computer.

If you have a sequencer program installed on your computer, you can use this USB connection to record and play your music. The M3 digital piano's recorder is actually a sequencer and the performance you record into the M3 digital piano's memory is MIDI performance data. Using a computer based sequencer program provides unlimited memory, editing, and posting on the Internet.



**MIDI Implementation Chart**

**Manufacturer:**  
Young Chang Music





**Model: M3IM3W**

**Date: 412/2012**  
**Version 1.0**



Function		Transmitted	Recognized	Remarks
Basic Channel	Default	1	1	Memorized
	Changed	1 - 16	1 - 16	
Mode	Default	Mode 3	Mode 3	Use Multi mode for multi-timbral applications
	Messages		All	
	Altered			
Note Number		0 - 127	0 - 127	Key Range: A0-C8
	True Voice	12 - 120	12 - 120	
Velocity	Note ON	O	O	
	Note OFF	O	O	
After Touch	Keys	X	X	
	Channels	X	O	
Pitch Bender		X	O	
Control Change		0, 32 Bank Select (MSB, LSB) 7 Volume 10 Pan 11 Expression 64 Sustain Pedal 66 Sostenuto Pedal 80 Sound Variation	O 0 - 31 32 - 63 (LSB) 64 - 127	
Program Change		O 0 - 127	O 0 - 127	
	True #	0 - 127	0 - 127	
System Exclusive		O	O*	
System Common	Song Pos.	X	O	
	Song Sel.	X	O	
	Tune	X	X	
System Real Time	Clock	X	O	
	Messages	X	O	
Aux Messages	Local Control	X	O	
	All Notes Off	X	O	
	Active Sense	X	X	
	Reset	X	X	
Notes	*Manufacturer's ID = 07 Device ID: default = 0			O = yes X = no



**Voice List**



No.	Voice Bank 1	Category Button
1	Grand Piano	
2	Pro Piano	
3	Grand Piano 2	
4	Piano & Strings	
5	Piano & Pad	
6	Piano & Vox	
7	Big Pop Piano	
8	Blues Piano	
9	Rock Piano	
10	Pop Upright	
11	Upright Piano	
12	Horowitz Piano	
13	Vanguard Piano	
14	Piano Recital	
15	Jazz Piano	
16	Bright Piano	
17	Piano Silk	
18	New Age Piano	
19	Piano Stack	
20	Piano Lushness	
21	Piano & Strings 2	
22	Air Piano	
23	Dreamy Piano	
24	Ivory Harp	
25	Stevie's Rhds	
26	Hotrod EP	
27	Fagen's Rhds	
28	These Eyes	
29	E Piano & Pad	
30	Misty Mtn. EP	
31	Supertramp EP	
32	Joni EP	
33	Ray's Wurly	
34	Austin Wurly	
35	Classic DX	
36	DX Pad	
37	90's DX	
38	Soft Ballad	
39	80's DX	
40	Classic 70's	
41	Power CP	
42	Gabriel CP	
43	Crisp Clav	
44	Steely Clav	
45	Fuzz Clav	
46	Wah Clav	
47	Talking Clav	
48	Zep Clav	
49	Stereo Clav	
50	Harpsichord	
51	Baroque Harpsi	
52	Piano Harpsi	
53	Celeste	

No.	Voice Bank 1	Category Button
54	Mellow Organ	
55	Perc Organ	
56	Gregg's B	
57	Perc Organ 2	
58	Melvin's Gospel	
59	Thick Gospel	
60	Prog Perc B3	
61	Traffic B3	
62	Warmer B3	
63	Blues & Gospel	
64	David's B3	
65	Growler B	
66	Rock B3	
67	Boston B	
68	Sweet Organ	
69	Gimmie B3	
70	Doors Vox	
71	Farfisa	
72	Pipe Stops	
73	Chapel Organ	
74	All Stops	
75	All Stops Choir	
76	Open Flute	
77	Stop Flute	
78	Diapason Organ	
79	Bourdon Organ	
80	Reed Organ	
81	Gamba Organ	
82	Celeste Organ	
83	Ballpark Stop	
84	Viol Organ	
85	2 Ft. Open Flute	
86	2 Ft. Stop Flute	
87	LA Strings	
88	Pop Strings	
89	Octave Strings	
90	Pizzicato	
91	Studio A Strings	
92	Mello Yes	
93	Octave Tron	
94	Lead Strings	
95	Lead Tutti Mix	
96	Aggressive Str	
97	Adagio Pizz	
98	Lead & Adagio	
99	Solo Violin	
100	Solo Viola	
101	Solo Cello	
102	Adagio Strings	
103	Slow Strings	
104	Mute Trumpet	
105	Bright Solo Tpt	
106	French Horn Solo	



## Voice List





No.	Voice Bank 1	Category Button
107	Brass Fanfare	<b>Brass Other</b> 
108	R&B Funk	
109	Horn Layer	<b>Wind Drums</b>  User
110	Brass Chorale	
111	Solo Tenor Sax	
112	Jazz Flute	
113	Fife & Drums	
114	Solo Flute	
115	Piccolo	
116	Mello Flute	
117	Oboe	
118	Clarinet	
119	Woodwinds	
120	Pan Flute	
121	Bottle Blow	

No	Voice Bank 2	Category Button
122	Horns & Strings	<b>Piano Ensemble</b>  Rock & Pop
123	Winds & Strings	
124	Gothic Orch	
125	Imperial Orch	
126	Battle Scene Orch	
127	Victory Orch	
128	Wind Express Str	
129	Pastoral Orch	
130	Silver Orch	
131	William Tell Str	
132	Daniel's Orch	
133	Slow Interlude	
134	White Satin Split	
135	Magic Orchestra	
136	Full Choir	<b>E.Piano Voice</b>  Modern
137	Haah Choir	
138	Manhattan Vocal	
139	Aaah Vocals	
140	Jazzy Scat	
141	Mello Choir	
142	Scat Choir	
143	Voice Oohs	<b>Clav Synth</b>  Latin
144	Lead Synth	
145	Piano Synth	
146	Synth Bell	
147	Sync Pulse	
148	Synth Orch	
149	Whale Call	
150	Echoplex	
151	Jupiter Synth	
152	Mini Pulse	
153	BPM Lead	
154	Gated Sweep	
155	Cars Synth	
156	Dive Bomb	
157	Heaven & Earth	

No.	Voice Bank 2	Category Button
158	Slow Pad	<b>KB3 Organ Pad</b>  Jazz
159	String Pad	
160	Spider Web	
161	Wispy One	
162	Airy Pad	
163	Innervate Pad	
164	Lush Pad	
165	Class Pad	
166	Bladerunner	
167	Fairlight Pad	
168	Airy Impact	
169	Deep Pad	
170	UFO Pad	
171	Alpha Pad	
172	Cosmic Sustain	
173	Acoustic Guitar	
174	Nylon Guitar	
175	12 String Steel	
176	Acoustic Gtr2	
177	Phaser Guitar	
178	Lead Guitar	
179	Fluid Guitar	
180	Vox 12	
181	Trem Humbucker	<b>Strings Bass</b>  World
182	Rockin' Lead	
183	E Bass	
184	P Bass	
185	Slap Bass	
186	Fretless Bass	
187	Upright Bass	
188	Levin Bass	
189	Sly Bass	
190	Lowdown Bass	
191	Real Vibes	
192	Marimba	
193	Harp Mallets	
194	Steel Drums	
195	Blue Man	
196	Mbira	
197	Xylophone	
198	Sitar	
199	Koto	
200	Accordion	<b>Wind Drums</b>  User
201	Solid Kit	
202	Latin Kit	
203	Brush Kit	
204	LA Kits	
205	Rock Kits	
206	Headhunters Kit	
207	Electric Kit	
208	Brooklyn Kit	
209	Snoop Kit	
210	Percussion Kit	

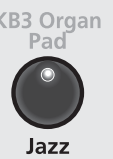
## Rhythm Patterns

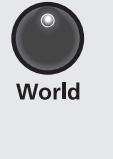
No.	Rhythm Pattern	Category Button
1	Ballad1	 Piano Ensemble Rock & Pop
2	Ballad2	
3	Ballad3	
4	Ballad4	
5	Ballad5	
6	Ballad6	
7	Ballad7	
8	Ballad8	
9	Pop1	
10	Pop2	
11	Pop3	
12	Pop4	
13	Pop5	
14	Pop6	
15	Pop7	
16	Pop8	
17	Rock1	
18	Rock2	
19	Rock3	
20	Rock4	
21	Rock5	
22	Rock6	
23	Rock7	
24	Rock8	
25	Triplet Rock	
26	Half-time Rock	
27	Twist	
51	R&B/Dance1	 E.Piano Voice Modern
52	R&B/Dance2	
53	R&B/Dance3	
54	R&B/Dance4	
55	R&B/Dance5	
56	R&B/Dance6	
57	R&B/Dance7	
58	Urban1	
59	Urban2	
60	Club1	
61	Club2	
62	Acid House	
63	Slow Jam	
64	Electro	
65	New Jack	
66	Breakbeat	
67	Gospel	
68	West Coast Hip-hop	
69	Revrn	
70	House Beat	
71	Syncopath	
101	Latin1	 Clav Synth Latin
102	Latin2	
103	Latin3	
104	Latin4	
105	Latin5	

No.	Rhythm Pattern	Category Button
106	Latin6	 Clav Synth Latin
107	Cha Cha	
108	Salsa	
109	Rumba	
110	Samba	
111	Samba 2	
112	Bossa Nova	
113	Son Clave	
114	Calypso	
115	Songo Calypso	
116	Songo	 KB3 Organ Pad Jazz
117	Mambo 1	
118	Mambo 2	
151	Jazz1	
152	Jazz2	
153	Jazz3	
154	Jazz4	
155	Jazz5	
156	Jazz6	
157	Jazz7	
158	Jazz8	
159	Spy Jazz	 Pipe Organ Guitar Country
201	Country1	
202	Country2	
203	Country3	
204	Country4	
205	Country6	
206	Country5	
207	Country7	
208	Country8	
209	Western	
251	World1	 Strings Bass World
252	World2	
253	World3	
254	World4	
255	World5	
256	World6	
257	Polka	
258	Reggae 1	
259	Nanigo 1	
260	Nanigo 2	
261	Maqsum	 Brass Other Metronome
262	Kherwa	
263	Afrobeat	
264	March	
265	Reggaeton	
266	Kpanlogo	
301	Metro 1/8nt	
302	Metro 1/16nt	
303	Metro 3/4	
304	Metro 6/8	
305	1/4 Metronome	
351	No rhythm	

## M3/M3W Features

Keyboard	M3W: Fatar 88 Note fully weighted Hammer Action Wood Keys with adjustable touch sensitive keys M3: Fatar 88 Note fully weighted Hammer Action Keys with adjustable touch sensitive keys
Preset Programs	200 Expressive sounds. 10 Drum Kits
Splits/Layers	Split /Layer, easy access with adjustable relative volume
Effects	Dual ambience and effect processors (reverberation and chorus). Rich and complex effects from the PC3 Series.
Drum Patterns	100 prerecorded patterns in a variety of styles
Recorder/Sequencer	2 Track Song Recorder with accompanying rhythm track
Sound System	50-watt (maximum) 4 speaker stereo sound system
Headphones	(2) 1/4" stereo headphone outs
I/O Jacks	MIDI In and Out connectors, 2 RCA Stereo Input & 2 RCA Stereo Output Jacks
USB	(1) Port, "Plug and Play" USB functionality allows MIDI over USB for connecting to/from an external computer sequencer; no software driver needed
Pedals	3 Pedals – Soft, Sostenuto, Sustain
Polyphony	64 voices
Finishes	Rosewood, White
Dimensions	54 3/4"w x 34 1/2"h x 19 5/8"d (1,380 x 877 x 487 mm)
Weight	134 lb. (61 kg)
Power	90 – 250 V AC free voltage external power supply ; 24 V 2.5 A DC

[www.kurzweil.com](http://www.kurzweil.com)

Facebook <http://www.facebook.com/kurzweilmusicsystems>

**KURZWEIL®**

**HDC** YOUNG CHANG  
MUSIC

Young Chang North America Kurzweil Home Products

6000 Phyllis Dr. Cypress, CA 90630

Tel : (310) 637-2000

Fax : (310) 637-2025

**Kurzweil Co., LTD**

iPark Building #102, Floor 9 Jeongja-Dong 9, Bundang-Gu

Soungnam-Shi, Gyeonggi-Do 463-859 South Korea

[www.ycpiano.co.kr](http://www.ycpiano.co.kr)

[www.youngchang.com](http://www.youngchang.com)

[www.kurzweil.com](http://www.kurzweil.com)

**TECHNICAL SUPPORT**

Email : [support@Kurzweil.com](mailto:support@Kurzweil.com)