

 **TRAKTOR AUDIO 6**

▼ **A** ▲
IN **THRU** **OUT**
● PHONO

▼ **B** ▲
IN **THRU** **OUT**
● PHONO



TRAKTOR AUDIO 6

PHONES

VOLUME



MAIN



Manual

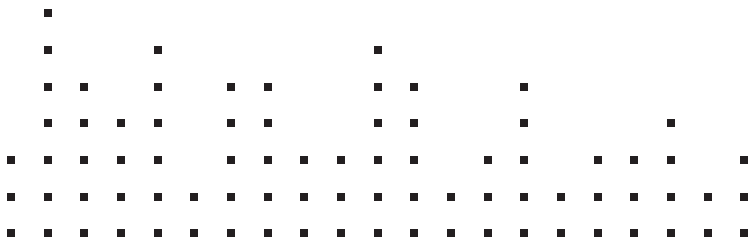

TRAKTOR AUDIO 6

Manual

Table Of Contents

1	Welcome to TRAKTOR AUDIO 6!	4
1.1	What is Included in the Box?	4
1.2	Manual Conventions	4
2	Safety Precautions	6
2.1	Risk of Damaging your Hearing	6
2.2	Caution	7
2.3	Notice.....	7
2.3.1	Disposal of the Product	7
2.3.2	Specifications Subject to Change.....	8
2.3.3	Disclaimer.....	8
3	Installation	9
3.1	System Requirements.....	9
3.2	Software Installation.....	9
3.2.1	Installing TRAKTOR AUDIO 6 on Windows 7	9
3.2.2	Installing TRAKTOR AUDIO 6 on Windows XP/Vista	12
3.2.3	Installing TRAKTOR AUDIO 6 on Mac OS X.....	15
3.3	Connecting the Hardware	19
3.4	Registration	21
4	Basic Configuration	22
4.1	Selecting the TRAKTOR AUDIO 6 as Your System's Default Audio Output Device.....	22
4.1.1	Windows XP	22
4.1.2	Windows Vista, Windows 7.....	22
4.1.3	Mac OS X.....	23
4.2	Using the TRAKTOR AUDIO 6 as an Audio Output Device with Music Software.....	23
4.3	Using the TRAKTOR AUDIO 6 with DJ Software.....	23
5	The Hardware in Detail	24
5.1	Front Panel.....	24
5.2	Rear Panel	25
5.3	Top Panel	26
6	Advanced Configuration	28
6.1	Advanced Configuration on Windows (Control Panel).....	28
6.1.1	Audio Settings Page.....	29
6.1.2	Channel Setup (Port Configuration on Windows).....	30
6.1.3	Diagnostics Page	34
6.2	Advanced Configuration on Mac OS X.....	36
6.2.1	Channel Setup (Port Configuration on Mac OS X)	36
6.2.2	Audio Configuration.....	39

7	Using the TRAKTOR AUDIO 6 (Setup Scenarios)	41
7.1	Analog DJing Setups	41
7.1.1	Connecting a Turntable for Analog DJing	41
7.1.2	Connecting a CD Deck for Analog DJing	45
7.2	Digital DJing Setups	48
7.2.1	Setting Up TRAKTOR AUDIO 6 for Internal Mixing	48
7.2.2	Setting Up TRAKTOR AUDIO 6 for External Mixing	51
7.2.3	Connecting Turntables for DJing with Timecode Vinyl	55
7.2.4	Connecting CD Decks for DJing with Timecode CDs	63
7.3	Miscellaneous Setups	70
7.3.1	Connecting Headphones	70
8	Troubleshooting	72
8.1	Solving Hardware-related Problems	72
8.2	How to Check Whether the TRAKTOR AUDIO 6 Drivers are Installed Correctly	72
8.3	USB Troubleshooting	73
8.3.1	USB 2.0 required	73
8.3.2	Try another USB cable	73
8.3.3	Using a powered USB 2.0 hub	73
8.3.4	Recommended USB-ports (MacBook Only)	74
8.3.5	Disable USB Energy Saving Mode (Windows only)	74
8.3.6	Update the Driver	74
8.4	Physically Re-configuring the TRAKTOR AUDIO 6	74
8.5	Check your IRQs (Windows only)	74
9	Getting Help	75
9.1	Readme / Knowledge Base / Technical Support	75
9.2	Forum	75
9.3	Updates	75
10	Appendix	76
10.1	About Latency and Buffers	76
10.2	Different Types of ASIO	76

1 Welcome to TRAKTOR AUDIO 6!

Thank you for your purchase of TRAKTOR AUDIO 6. It is the ultimate hardware complement for a variety of home studio and DJ applications. The TRAKTOR AUDIO 6 provides the following features:

- USB 2.0 soundcard, based on the new XMOS audio platform
- 6 Ins / 6 Outs (RCA)
- Phono preamps for input channels on ports A and B
- “Direct Thru” option on ports A and B for analog mixing
- Headphones output
- 24-bit / 96 kHz Cirrus Logic audio interface
- ASIO, Core Audio, Directsound and WASAPI driver support
- Stand-alone functionality (only in combination with the dedicated DC power supply; see chapter 5.2 for further information on the power supply)

1.1 What is Included in the Box?

The package contains:

- 1 x TRAKTOR AUDIO 6 audio interface
- 1 x shielded USB 2.0 cable
- 1 x driver installation disc
- 1 x DC power supply (if you obtained the TA6 as part of a TRAKTOR software package)
- A printed copy of this manual
- The TRAKTOR LE 2 DJ software
- KOMLETE 7 PLAYERS software bundle

1.2 Manual Conventions

This manual uses particular formatting to point out special facts and to warn you of potential issues. The icons introducing the following notes let you see what kind of information is to be expected:



Whenever this exclamation mark icon appears, you should read the corresponding note carefully and follow the instructions and hints given there if applicable.



This lightbulb icon indicates that a note contains useful extra information. This information may often help you to solve a task more efficiently, but does not necessarily apply to the setup or operating system you are using; however, it's always worth a look.

Furthermore, the following formatting is used:

- Text appearing in (drop-down) menus (such as *Open...*, *Save as...* etc.) and paths to locations on your hard drive or other storage devices is printed in *italics*.
 - Text appearing elsewhere on the screen (labels of buttons, controls, text next to checkboxes, etc.) is printed in **light blue**. Whenever you see this formatting applied, you will find the same text appearing somewhere on the screen.
 - Important names and concepts are printed in **bold**.
 - References to keys on your computer's keyboard you'll find put in square brackets (e.g., "Press [Shift] + [Return]").
- ▶ Single instructions are introduced by this play button type arrow.
- Results of actions are introduced by this smaller arrow.

Pet Names for the Hardware

Throughout the documentation, we will refer to the TRAKTOR AUDIO 6 hardware whether as "TRAKTOR AUDIO 6" or abbreviate "TA6."

2 Safety Precautions

Before using the TRAKTOR AUDIO 6, thoroughly read the following instructions. This will provide you with important information needed for setting up and using your TRAKTOR AUDIO 6 safely.



Keep this document in a safe place for further reference.

In case you obtained the TRAKTOR AUDIO 6 as part of a TRAKTOR software package, the box contains a power supply for the soundcard. If not, you can purchase the power supply separately on the NI webshop. The power supply is not mandatory for operating the soundcard, it is only needed for using the TA6 in stand-alone mode (without employing a computer).



WARNING

**RISK OF ELECTRIC SHOCK
DO NOT OPEN**



**TO REDUCE THE RISK OF ELECTRIC SHOCK, DO NOT OPEN OR MODIFY
THE PRODUCT'S POWER SUPPLY.
THE POWER SUPPLY CONTAINS NO USER-SERVICEABLE PARTS.**



The exclamation point, within an equilateral triangle, is intended to alert you to the presence of important operating and maintenance instructions in the literature accompanying the product.



The lightning flash, within an equilateral triangle, is intended to alert you to the presence of uninsulated dangerous voltage that may cause personal injury.

2.1 Risk of Damaging your Hearing

The TRAKTOR AUDIO 6, in combination with an amplifier, headphones or speakers, can produce sounds in decibel ranges that may cause hearing damage. For your protection, set all volume levels to a minimum before using TRAKTOR AUDIO 6. Gradually raise the volume controls while music is playing to set the desired listening level. If you experience any hearing problems or ringing in the ears, consult a hearing specialist immediately.

2.2 Caution

It is important you read and understand the following instructions to make sure the TRAKTOR AUDIO 6 or any device connected will not be damaged during usage or maintenance:

- Do not use the product's power supply if it appears to be malfunctioning. Discontinue use immediately and have the device inspected by qualified service personnel.
- Do not connect the TRAKTOR AUDIO 6 to power supplies of types not identical to the one delivered with the device.
- Do not open the TRAKTOR AUDIO 6 or attempt to disassemble or modify any internal parts. The TRAKTOR AUDIO 6 does not contain any user-serviceable parts. If the device appears to be malfunctioning, discontinue use immediately and have the device inspected by qualified service personnel.
- Do not expose the unit to rain, use it near water or in damp or wet conditions.
- Make sure no objects or liquids of any kind penetrate the unit. When cleaning the TRAKTOR AUDIO 6, use a soft, dry cloth. Never use paint thinners, solvents, cleaning fluids, or chemical-infused wiping cloths.
- Never use or store the unit in areas subject to extreme temperatures (e.g., direct exposure to sunlight in an enclosed vehicle or near heat-generating equipment), or high levels of vibration.
- Always let the TRAKTOR AUDIO 6 adapt to changed room temperature after it has been stored in a cold environment.
- Do not place the TRAKTOR AUDIO 6 in an unstable position where it could accidentally fall.
- Turn off electronic devices (e.g., mixers, amplifiers or active speakers) before connecting them to the TRAKTOR AUDIO 6.
- Before moving the TRAKTOR AUDIO 6, remove all connected cables.
- Disconnect the TRAKTOR AUDIO 6's power supply from the power outlet during thunderstorms or when leaving the TRAKTOR AUDIO 6 unused for a long period of time.
- Do not use excessive force on buttons, knobs, switches and connectors if any parts should appear to be malfunctioning. Discontinue use immediately and have the TRAKTOR AUDIO 6 inspected by qualified service personnel.

2.3 Notice

2.3.1 Disposal of the Product

Should this product become damaged beyond repair, or if you wish to dispose it, please observe the regulations of your area and country that relate to the disposal of electronic products.

2.3.2 Specifications Subject to Change

The information contained in this manual is believed to be correct at the time of printing or digital release. However, Native Instruments reserves the right to make changes to the specifications at any time without notice or obligation to update existing units.

2.3.3 Disclaimer

Native Instruments GmbH cannot be held responsible for damage or lost or destroyed data caused by improper use or modification of TRAKTOR AUDIO 6.

3 Installation

In order for the TRAKTOR AUDIO 6 to work properly with your computer, the following two programs are automatically installed on your system during the software installation process:

- The TRAKTOR AUDIO 6 driver. This handles the communication between the audio interface and your computer.
- The Control Panel software:
 - In Windows, the Control Panel software allows you to adjust performance settings, preamp settings, to perform diagnostics, and to configure the soundcard's port settings.
 - In Mac OS X, the performance settings and preamp settings are controlled from the system's Audio MIDI setup, located in the [Utilities](#) folder. The port configuration again is accessed through the Control Panel software.



If you are familiar with the installation procedure and the general configuration of USB-driven audio devices on your computer, you can skip this chapter and continue with registration chapter 3.4.

3.1 System Requirements

For the latest system requirements of your product, please visit the product page at <http://www.native-instruments.com/TA6>.

3.2 Software Installation

3.2.1 Installing TRAKTOR AUDIO 6 on Windows 7



Do not connect the TA6 to your computer before the software installation process is finished.

To install the TRAKTOR AUDIO 6 on Windows 7:

1. Place the installation disc in your computer's CD/DVD-ROM drive.
2. Use Windows Explorer to browse the contents of the disc.
3. Double-click the installer file: "TRAKTOR AUDIO 6 Setup PC.exe."

4. In the installation welcome screen, click [Next](#).



5. To continue, you need to first accept the license agreement. After you have read the license agreement, click on the corresponding checkbox. Then click [Next](#).

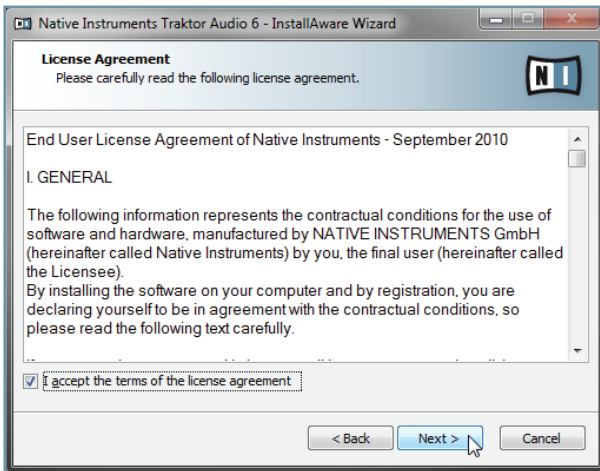

- The InstallAware Wizard will prompt you to begin the configuration. Click [Next](#) to proceed.



- Once the installation has been performed successfully, click [Finish](#).

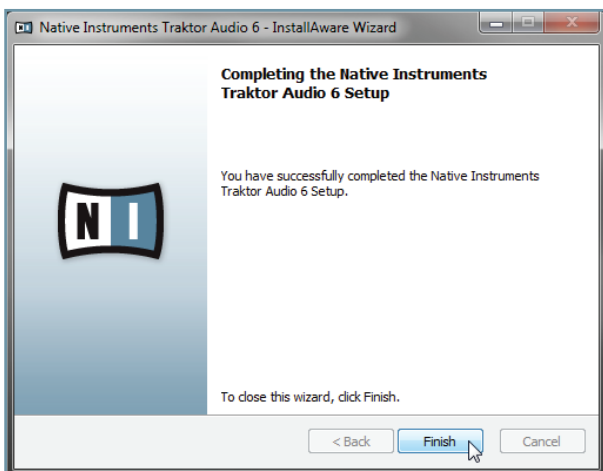

- Proceed with connecting the hardware as described in chapter 3.3.

3.2.2 Installing TRAKTOR AUDIO 6 on Windows XP/Vista

 Do not connect the TA6 to your computer before the software installation process is finished.

To install the TRAKTOR AUDIO 6 on Windows XP/Vista:

1. Place the installation disc in your computer's CD/DVD-ROM drive.
2. Use the Windows Explorer to browse the contents of the disc.
3. Double-click the installer file: "TRAKTOR AUDIO 6 Setup PC.exe."
4. In the installation welcome screen, click [Next](#).



- To continue, you first need to accept the license agreement. After you have read the license agreement, click on the corresponding checkbox. Then click [Next](#).

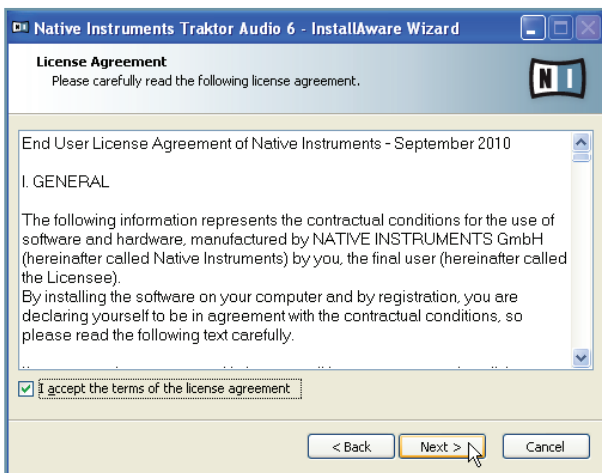

- The InstallAware Wizard will prompt you to begin the configuration. Click [Next](#) to proceed.



- During driver installation, a Windows security warning will appear. This does not indicate a problem. To proceed with the installation, click [Continue Anyway](#) (on Windows XP) or [Install](#) (on Windows Vista).

8. Once the installation has been performed successfully, click Finish.

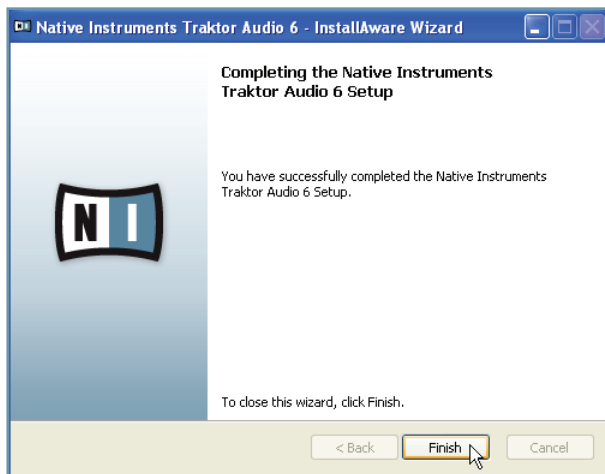

9. Proceed with connecting the hardware as described in chapter 3.3.

3.2.3 Installing TRAKTOR AUDIO 6 on Mac OS X

To install the TRAKTOR AUDIO 6 on Mac OS X:

1. Place the installation disc in your computer's CD/DVD-ROM drive. Its icon will appear in the Mac OS X Finder.
2. Double-click the TRAKTOR AUDIO 6 disc icon to display the contents of the disc.
3. Double-click the installer file: "Traktor Audio 6 Installer Mac.mpkg." The installation will start, and a welcome screen will appear.
4. Click [Continue](#) to proceed.



5. Read the Software License Agreement and click [Continue](#) to proceed.



6. If you agree to the Software License Agreement, click [Agree](#) to continue.

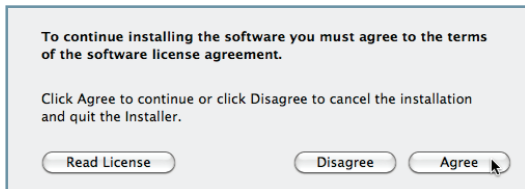

7. Select the drive you want to install the TRAKTOR AUDIO 6 driver to and click [Continue](#).



- Click [Install](#) to install the driver.

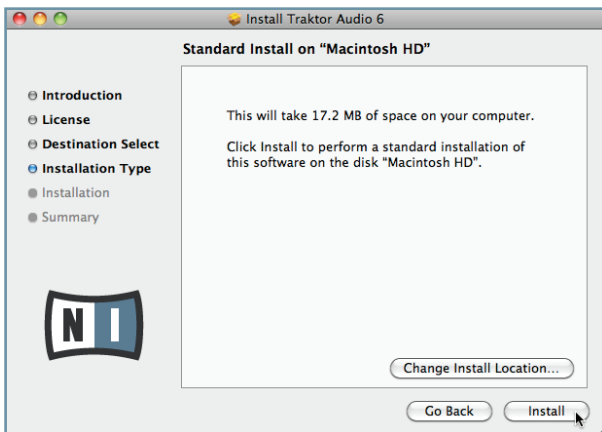

- Mac OS X will prompt you to authenticate the installation. Enter the name and corresponding password of a user with administrator privileges.

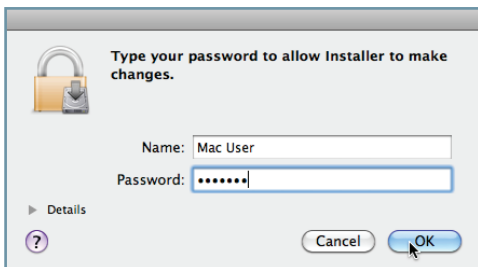

10. Once the installation has been performed successfully, you will be prompted to restart your Mac. Click the [Restart](#) button to complete the installation.

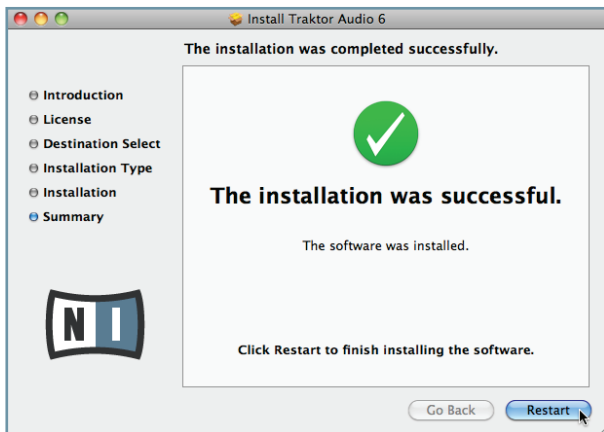

11. Proceed with connecting the hardware as described in section 3.3.

3.3 Connecting the Hardware

Before connecting the hardware, make sure you have installed all software components as described in chapter 3.2. Once you have installed the software:

! Steps 1 to 3 are only relevant if you obtained the TA6 as part of a TRAKTOR software package; in that case, the box contains a DC power supply for powering the soundcard. The power supply is not mandatory for operating the soundcard, it is only needed for using the TA6 in stand-alone mode. You can purchase the power supply separately in the NI webshop.

1. Insert the fixture of the matching adapter plug into the corresponding part on the power supply, then press the adapter plug carefully against the power supply until a click confirms the adapter plug has snapped into place.

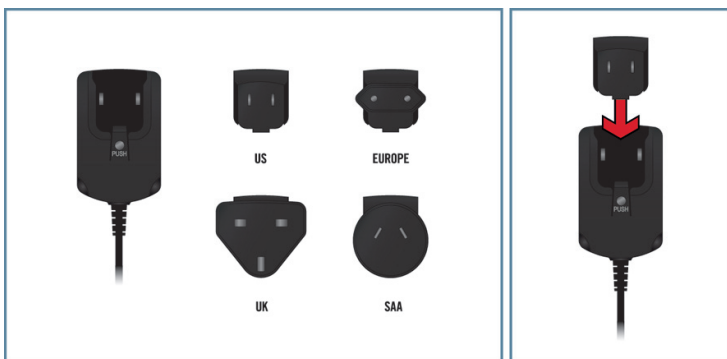

2. Connect the power supply to a power outlet.

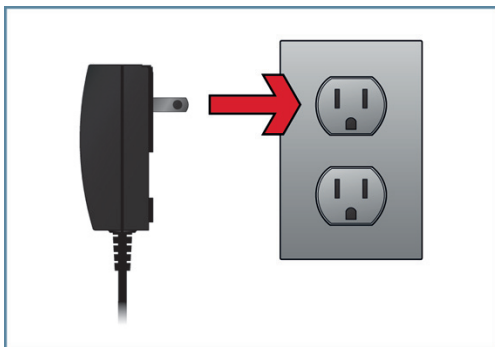

3. Connect the plug at the end of the power supply's cable to the power supply connector on the rear panel of your TA6.

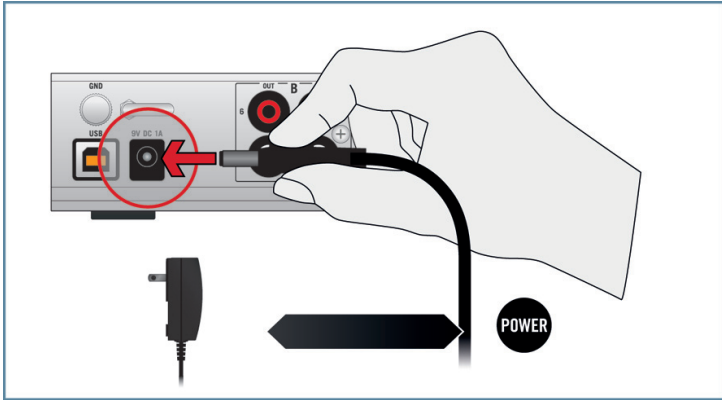

4. Connect the TA6 to a USB 2.0 port on your computer using the USB cable included in the package.

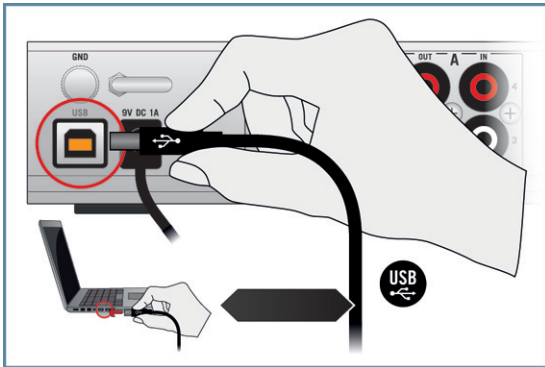

- After connecting the soundcard to your computer, the USB drivers will be installed on your computer automatically and the TRAKTOR AUDIO 6 soundcard should be ready to use straight away. Proceed with registration chapter 3.4. **For Windows XP, see separate section below.**

XP Users Only: Completing the Device Driver Installation

Upon detection of the new hardware, Windows completes the device driver installation:

1. Windows XP will identify the TRAKTOR AUDIO 6 soundcard. Choose **No** if Windows asks you to search the internet for a driver.
2. During device driver installation, a Windows message may call attention to the fact that the TRAKTOR AUDIO 6 driver has not passed Windows Logo Testing. This is an expected behavior and does not indicate a problem. To proceed, click **Continue Anyway**.
 - Your computer will display a “**New Hardware found**” message. Subsequently, another message reading “**Your devices are ready to use**” will notify you that the device driver installation was completed successfully.
 - ▶ After you have completed the driver installation procedure, the driver installer will start again. This is intended behavior. Repeat the previous steps in order to install all required driver components.
 - All software components are now installed, and the TRAKTOR AUDIO 6 should be ready to use. Proceed with registration chapter 3.4.

3.4 Registration

Registering the TRAKTOR AUDIO 6 is not mandatory. Nevertheless, registration is recommended for support inquiries or in case of theft. As a registered user, you will also benefit from exclusive incentives and insider specials.



To register your TRAKTOR AUDIO 6 on the Native Instruments website, you will need the serial number from the product activation sticker. This is located on the bottom panel of your TRAKTOR AUDIO 6.

To register your TRAKTOR AUDIO 6:

- ▶ Visit our registration page on: <http://www.native-instruments.com/registration> and follow the on-screen instructions.

Proceed with chapter 4.

4 Basic Configuration

In order for the TRAKTOR AUDIO 6 to operate as your computer's default audio output device, you will need to select it within the system's audio preferences. Find the relevant instructions in chapter 4.1.

For information on using the TRAKTOR AUDIO 6 as your music software's default audio output device, see chapter 4.2.

For information on using the TA6 with TRAKTOR DJ or other DJ software, see chapter 4.3.

4.1 Selecting the TRAKTOR AUDIO 6 as Your System's Default Audio Output Device

In the following sections, you will learn how to set up the TRAKTOR AUDIO 6 as your computer's default audio output device.

4.1.1 Windows XP

1. Open *Start > Control Panel > Hardware and Sound > Sound*.
 2. In the [Sounds and Audio Devices Properties](#) window, select the [Audio](#) tab.
 3. From the [Default Device](#) drop-down list of options, select TRAKTOR AUDIO 6.
 4. Click [OK](#) to confirm your selection and close the window.
- TRAKTOR AUDIO 6 is now selected as the default audio output device.

4.1.2 Windows Vista, Windows 7

1. Open *Start > Control Panel > Hardware and Sound > Sound*.
 2. In the [Sound](#) control panel, select the [Playback](#) tab.
 3. Choose from one of TRAKTOR AUDIO 6's pair of outputs (Ch A, Out 1|2 or Ch B, Out 3|4) that you want to set as default by clicking the corresponding entry.
 4. Click [Set Default](#).
 5. Click [OK](#) to confirm your selection and close the window.
- TRAKTOR AUDIO 6 is now selected as the default audio output device.

4.1.3 Mac OS X

1. Open the [System Preferences](#) under the gray Apple Icon menu in the top left corner of your screen.
 2. In the *Hardware* category (second row from top), select *Sound*.
 3. In the *Sound* control panel, select the *Output* tab.
 4. Choose TRAKTOR AUDIO 6 from the list of available soundcards.
 5. Close the panel.
- TRAKTOR AUDIO 6 is now selected as the default audio output device.

4.2 Using the TRAKTOR AUDIO 6 as an Audio Output Device with Music Software

Before using the TRAKTOR AUDIO 6 with music production or DJ software, you will need to set it up as the software's audio output device. Most music production and DJ programs provide direct access to the soundcard properties in the audio and MIDI setup section of their preferences dialog. Please refer to the documentation of your music production or DJ software for information on how to configure audio and MIDI interfaces.

4.3 Using the TRAKTOR AUDIO 6 with DJ Software

For instructions on how to utilize TRAKTOR DJ software for mixing purposes with a dedicated hardware audio interface, please see the documentation of your TRAKTOR software.

For the TRAKTOR AUDIO 6 to work in a digital DJing context (with timecode media), it is important that the input channels on the relevant ports are set up for receiving timecode, i.e., THRU mode is **deactivated** and the channels are set to PHONO or LINE (see soundcard's top panel LEDs), depending on whether you use timecode vinyl or CD decks sending timecode. See chapter 6.1.2 / 6.2.1 for instructions on how to configure the port settings. See chapter 7.2 for instructions on how to set up the TA6 to work with DJ software.

5 The Hardware in Detail

The TRAKTOR AUDIO 6 is a soundcard for processing incoming audio and sending audio to your computer and other external equipment, both in analog and digital form.

Geared for DJ use, the TA6 involves the use of turntables, CD decks and other line level devices. Turntables and CD decks can either be used for analog playback or for use with timecode vinyls/CDs to control audio files in a DJing software. With the flexible port configuration options, you can even set up a combination of analog and digital DJing. See chapter 6.1.2 / 6.2.1 for instructions on how to configure the port settings with the Control Panel software, which was installed during the TA6 software installation procedure.

The following are the key features of the TRAKTOR AUDIO 6:

- sound conversion (from analog to digital and vice versa)
- playback/monitoring (from an input device or computer to headphones/speakers)
- use of timecode vinyls/CDs

5.1 Front Panel



5.1 The front panel of the TRAKTOR AUDIO 6.

- **(1) Headphone section:**
 - The headphones section has a 1/4" stereo socket (**MAIN**) for connecting headphones with a 1/4" stereo jack.
 - The **VOLUME** knob in this section controls the output signal to the headphones.
- **(2) MAIN:** The **MAIN IN/OUT** input and output channels are unbalanced connectors. These are the main inputs/outputs of the TRAKTOR AUDIO 6; however, in a TRAKTOR SCRATCH (or other DJ software) context, you would rather utilize the output port as an additional output for Sample Deck / Loop Recorder signal, whereas your "main" channel signals would be coming from the rear panel's channel outputs on ports A and B.

5.2 Rear Panel



5.2 The rear panel of the TRAKTOR AUDIO 6.

- **(1) Grounding Post (GND):** The **grounding post** at the upper left is where the ground wire for all turntables can be affixed. Grounding your turntable is essential in eliminating mostly the low frequency buzzing noises and some pops and hisses.
- **(2) USB Port:** The **USB** port connector connects the TRAKTOR AUDIO 6 soundcard to your computer or workstation via USB 2.0 and exchanges data with your computer.
- **(3) DC Adapter Socket:** A 9 volt DC power supply attaches to this socket.

! If you obtained the TA6 as part of a TRAKTOR software package, the soundcard comes with a DC power supply. In case you bought the TA6 without TRAKTOR, there is no power supply boxed with the soundcard. The power supply is not mandatory for operating the soundcard, it is only needed for using the TA6 in stand-alone mode (see setup examples in chapter 7.1). You can purchase the power supply separately in the NI webshop.

! Note that when powering the TA6 via USB solely, the headphone output amplification is slightly lower than with a DC power supply plugged in.

- **(4) Ports A and B:** A port on the TA6 consists of an input channel and an output channel. The ports A and B connect to two input devices (line and phono). They can output audio to two different output devices / mixer channels. The sockets are unbalanced connectors. They are used for input devices such as a turntable, synth, tapedeck, CD player, or any other device or instrument without the need for phantom powering. Both ports can process timecode information. In a generic digital DJing setup, a turntable is connected to the IN channel of a port, which forwards timecode from the timecode record to the computer software. The resulting audio signal will be sent to the same port's output channel, and further on to a mixer channel or another desired output device. The ports also provide a Direct Thru function (THRU) allowing the sending of a signal from a port's input channel directly to the port's output channel, therein bypassing the internal signal processing which is useful for analog DJing.

! Please note: In order for timecode vinyl/CDs to work with the TRAKTOR AUDIO 6, the ports have to be configured correctly! For further instructions on configuring the port settings, please read chapter 6.1.2 / 6.2.1.

5.3 Top Panel



5.3 The top panel on the TRAKTOR AUDIO 6

The **STATUS LEDs** allow you to quickly identify the status of any connections going into and coming out of the device, especially in low lighting environments. A list of the individual LEDs and their functions:

- **Ports A and B:**
 - **IN** and **OUT** light green when incoming/outgoing signal is detected. The INs light red when the incoming signal is clipping (too loud).
 - The **THRU** indicator lights orange when a port is set to send the signal of its input channel directly to its output channel which is useful for analog mixing. When using a timecode medium (vinyl/CD), the signal coming through to the channel is digital and needs to be processed by your computer. At this point, the **THRU** function needs to be deactivated. See chapter 6.1.2 / 6.2.1 for further information on configuring the port settings.

- **PHONO** needs to be active when using a port with a turntable (no matter if using timecode vinyl for digital mixing or using standard vinyl records). See chapter 6.1.2 / 6.2.1 for further information on configuring the port settings.



By default, the soundcard is set to PHONO with activated THRU mode on ports A and B for mixing analog signal from turntables. See chapter 6.1.2 / 6.2.1 for instructions on how to change the default settings.

- **MAIN IN** and **OUT**: **IN** and **OUT** light green when there is incoming/outgoing audio signal on the front panel's MAIN port. The IN LED lights red when the incoming signal is clipping (too loud).
- **DC**: Lights orange when the 9 volt DC power adapter is plugged in.



If you obtained the TA6 as part of a TRAKTOR software package, the soundcard comes with a DC power supply. In case you bought the TA6 without TRAKTOR, there is no power supply boxed with the soundcard. The power supply is not mandatory for operating the soundcard, it is only needed for using the TA6 in stand-alone mode (see setup examples in chapter 7.1). You can purchase the power supply separately in the NI webshop.



Note that when powering the TA6 via USB solely, the headphone output amplification is slightly lower than with a DC power supply plugged in.

- **USB**: Lights green when the USB port is connected to a computer. A blinking green, however, indicates a USB connection problem.
- **PHONES**: lights orange when monitoring the incoming signal of the MAIN IN channel, which is located on the front panel of the soundcard.

6 Advanced Configuration

On Windows

All advanced configuration settings on Windows can be accessed from the Control Panel software, which was installed on your computer during the software installation procedure in chapter 3. You should open the Control Panel once you have installed the drivers, connected the hardware to your computer, and set up the interface as your default audio output device (see chapter 4). In this chapter, you will learn about the Control Panel and what you can do with it. Proceed with chapter 6.1.



If you experience problems with your setup, please refer to the Audio Troubleshooting Guide, which you can access from the [Information](#) section of the Control Panel's [Diagnostics](#) page, or open it directly from the software's documentation folder.

On Mac OS X

On Mac OS X, there are separate dialogs for configuring the TRAKTOR AUDIO 6 port settings and for configuring the audio and MIDI settings:

- The port configuration takes place in the Control Panel software (*Applications > Native Instruments > TRAKTOR AUDIO 6 Driver > TRAKTOR AUDIO 6 Control Panel*), which was installed on your computer during the software installation procedure in chapter 3.
- The advanced audio and MIDI settings are accessed from the Mac OS X Audio MIDI Setup, located in the *Applications > Utilities* folder. Open the Audio MIDI Setup once you have connected the hardware to your computer, installed the drivers (chapter 3), and set up the interface as your default audio device (see chapter 4).

Proceed with chapter 6.2.



If you experience problems with your setup, please refer to the Audio Troubleshooting Guide, which you can access directly from the software's documentation folder.

6.1 Advanced Configuration on Windows (Control Panel)

The Control Panel software allows you to configure the port settings, change the driver's performance settings, monitor performance, and detect errors. To open the Control Panel:

- ▶ Navigate to *Start > All Programs > Native Instruments > TRAKTOR AUDIO 6 Driver > Control Panel*.



If you cannot find the Control Panel, the software is most likely not installed. In this case, please (re-)install the software as described in chapter 3.

On the left-hand side of the Control Panel, you find three tabs: [Audio Settings](#), [Channel Setup](#), and [Diagnostics](#):

- ▶ Click on the tabs to open the corresponding page of the Control Panel.

Proceed to chapters 6.1.1, 6.1.2, and 6.1.3 for more information on the Control Panel's pages.

6.1.1 Audio Settings Page

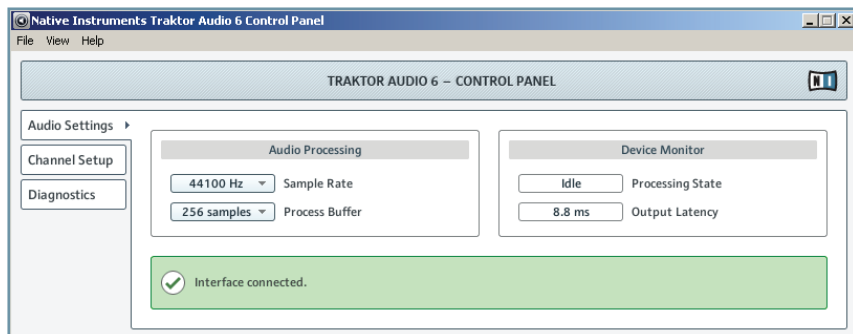

6.1 The Control Panel's [Audio Settings](#) page.

In the [Audio Settings](#) page, you can configure the audio latency and sample rate, and monitor the device's status.

The [Audio Settings](#) page consists of two sections: [Audio Processing](#) and [Device Monitor](#). See the following subchapters for further information.

Audio Processing Section

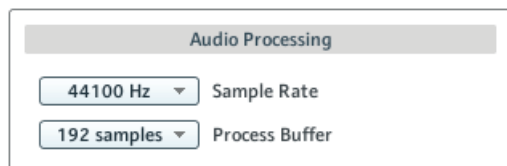

6.2 The [Audio Processing](#) section in the [Audio Settings](#) page of the Control Panel.

The [Audio Processing](#) section sets parameters for the analog-to-digital/digital-to-analog conversion done by your audio interface. It has two menus:

- **Sample Rate:** Choose a sample rate that is compatible with your music application and best suited to your computing power. A higher sample rate improves the audio quality, but also causes higher CPU load. By default, the sample rate is set to 44100 Hz (CD quality).



The sample rate defines how many samples are played/recorded per one second of sound. A higher sample rate results in higher audio quality; however, 44100 Hz (as used for recording audio CDs) is a common setting and absolutely sufficient for most tasks. If your final destination is CD, you should use this setting or a multiple of it (88200 Hz). For a better understanding: 48000 Hz is used by DAT recorders and for DVD (films) recording. 96000 Hz and higher rates are typical for DVD, HD DVD, and Blu-ray Disc audio recording. You should be aware that a higher sample rate also causes higher CPU load.

 If you want to use multiple software clients simultaneously with the device, keep in mind they'll also have to share the same sample rate.

- **Process Buffer:** Lower the buffer size value for a quicker response time from your computer to audio software actions.

 When converting audio information to digital and vice versa, the audio driver needs to store the data in buffer packages (audio buffers), which are then sent to and processed by the CPU. The higher the buffer size, the longer it takes for a signal to finally arrive at the output as audio. You might experience this as a delay between the time you hit a key on your computer or controller and when you actually hear the sound. This delay is called latency. A rule of thumb: lowering buffer size results in lower latency. However, there are more factors to latency than buffer size alone (e.g., CPU speed and RAM size). Start off with a higher buffer size setting and gradually decrease the value until you find the perfect balance between audio quality and system performance. If you experience crackling at the audio output, the chosen buffer size is very likely too low for your computer's CPU to handle considering that a lower buffer size causes higher CPU load.

Device Monitor Section

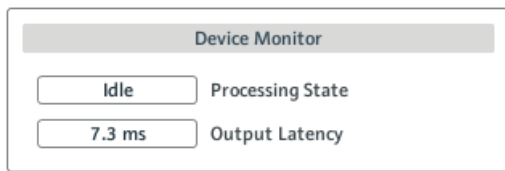

6.3 The **Device Monitor** section in the **Audio Settings** page of the Control Panel.

The **Device Monitor** section displays information about the audio interface's processing status and your system's output latency. It has two displays:

- **Processing State:** The processing state monitor provides feedback on the current status of the device. There are three possible status messages:
 - **Idle:** interface is connected, but no client delivers audio data.
 - **Streaming:** driver is working and processing audio data.
 - **Panic:** driver stopped streaming. Too many USB I/O errors occurred in the interface communication.
- **Output Latency:** Shows the amount of output latency in milliseconds.

6.1.2 Channel Setup (Port Configuration on Windows)

The **Channel Setup** page allows you to configure the port settings (ports A and B) of your TRAKTOR AUDIO 6. This area determines whether a port is set to amplify **Phono** or **Line** signal and if the incoming signal should bypass internal processing by your computer (**Direct Thru**) and be sent to the output channels immediately or not. You can furthermore choose between configuring a temporary (**Current**) and a default setting (**Startup**) for each port.

 By default, the soundcard is set to **Phono** with activated **Direct Thru** mode on ports A and B for mixing analog signal from turntables.

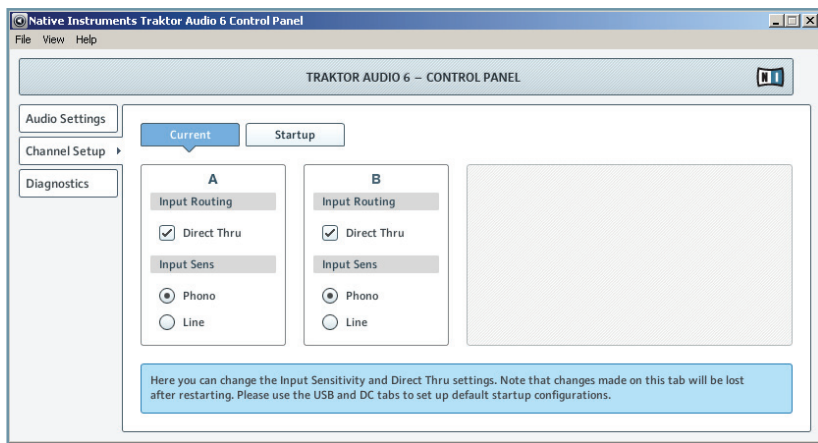

6.4 The Channel Setup page

Port Options

The port configuration area of each port (A and B) contains two control sections: **Input Routing** and **Input Sens**:

- **Input Routing:**
 - Tick the **Direct Thru** checkbox if you want the incoming signal to bypass internal processing by your computer. This function is intended for **analog mixing** where you may want the incoming signal (e.g., when mixing in records from a turntable) to be sent directly from the port's input to the port's output channels. Note: When using the soundcard for analog mixing in **stand-alone** mode (without a computer), **Direct Thru** has to be activated. See the Temporary and Default Settings subsection below for instructions on how to configure the soundcard's behavior on initial start up. Note, however, that you need a DC power supply to operate the soundcard in stand-alone mode. If you did not obtain the TA6 as part of a TRAKTOR software package, you can purchase the power supply separately from the NI webshop.
 - Deactivate the **Direct Thru** option for **digital mixing** (when using timecode vinyl or timecode CDs). The signal has to be sent through your computer for the timecode data to be processed by your DJ software.
- **Input Sens:**
 - Select **Phono** for when connecting a **turntable** to the port (no matter if digital mixing with timecode vinyl or analog mixing with records; both need phono amplification).
 - Select **Line** for when connecting a **CD deck** to the port (or other line level equipment such as a synthesizer, an MP3 player, a tapedeck, etc.).

Both ports A and B may be used by one of the following devices: a turntable with analog records, a turntable with timecode vinyl, a CD deck, a CD with a timecode disc, or any other line device.



By default, the soundcard is set to **Phono** with activated **Direct Thru** mode on ports A and B for mixing analog signal from turntables.

Temporary and Default Settings (Current and Startup)

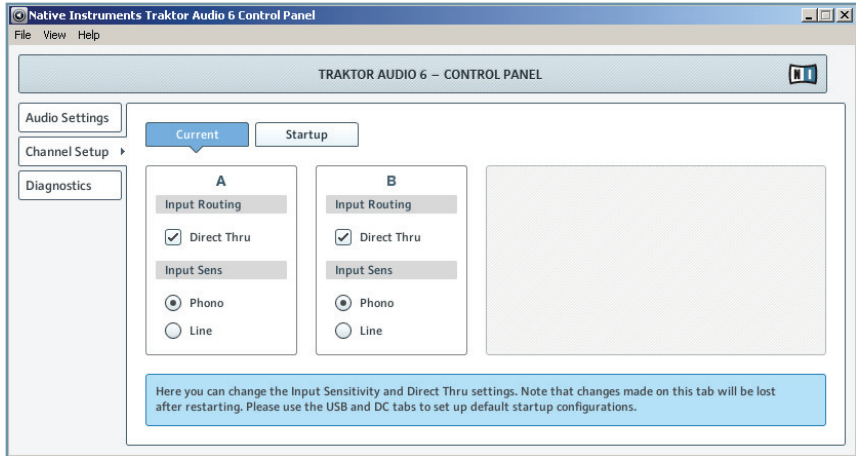

6.5 The Channel Setup with the **Current** settings tab selected.

The **Channel Setup** page holds two tabs for configuring the ports on your TRAKTOR AUDIO 6: the **Current** settings and the **Startup** settings tab:

- On initial start-up, the **Current** settings reflect the settings from the **Startup** settings tab (which holds the default settings). You can temporarily change the **Current** settings, and they remain changed for as long as the device is powered.



When using a DC power supply (see also chapter 5.2), unplugging the USB cable does not affect the **Current** settings.

- The **Startup** settings tab holds the port settings that the soundcard defaults to when the device is initially plugged in with DC power (see also chapter 5.2 for more information on the power supply). To apply changes here, you first have to click on the lock symbol in the **Click the lock to make changes** dialog box. Confirm your changes by clicking the **Save** button.



If you obtained the TA6 as part of a TRAKTOR software package, the power supply comes boxed with the soundcard. In case you bought the TA6 without TRAKTOR, there is no power supply boxed with the soundcard. The power supply is not mandatory for operating the soundcard, it is only needed for using the TA6 in stand-alone mode (see setup examples in chapter 7.1). You can purchase the power supply separately in the NI webshop.

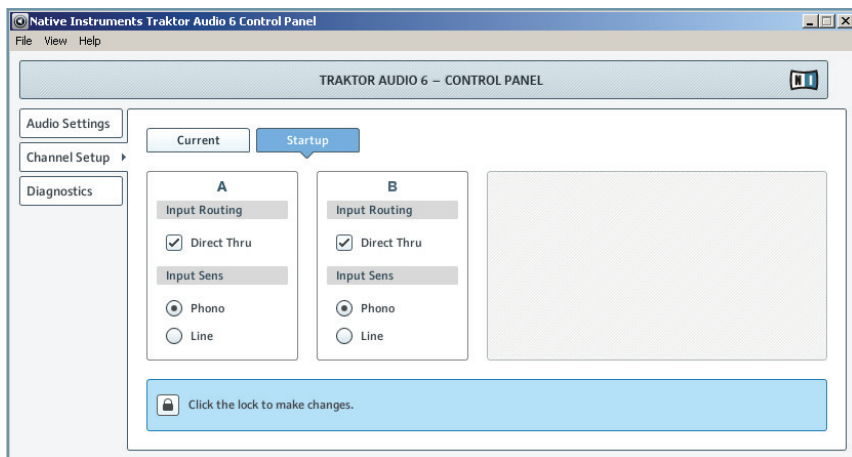

6.6 The Channel Setup with the [Startup](#) settings tab selected.



By default, the soundcard is set to [Phono](#) with activated [Direct Thru](#) mode on ports A and B for mixing analog signal from turntables.



If you want to use the TRAKTOR AUDIO 6 in stand-alone mode (without employing a computer), the [Startup](#) settings have to be set to [Direct Thru](#) on the relevant ports so the input channels forward the signal to the output channels. With [Direct Thru](#) deactivated, you will not hear any output on the relevant ports when running the soundcard in stand-alone mode.

6.1.3 Diagnostics Page

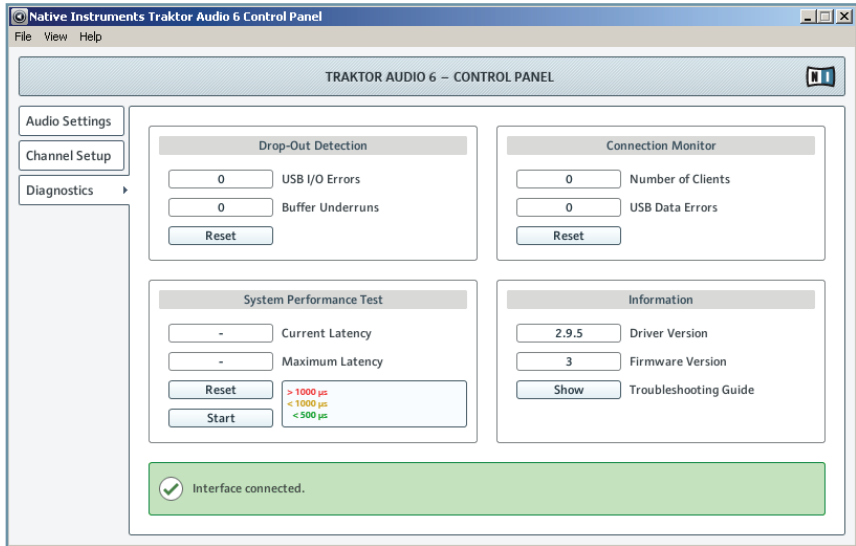

6.7 The Control Panel's **Diagnostics** page.

The **Diagnostics** page allows you to monitor performance and detect errors. The information provided in this page is primarily of interest to advanced users; however, in case of problems with the soundcard, you should have a look at this page. The **Diagnostics** page consists of the four sections: **Drop-Out Detection**; **Connection Monitor**; **System Performance Test**; and **Information**. See the following subchapters for further information on these sections.

Drop-Out Detection Section

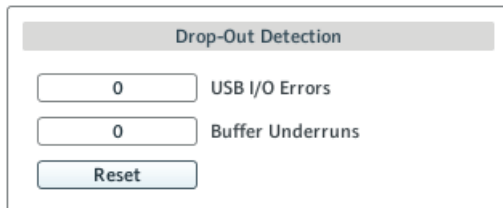

6.8 The **Drop-Out Detection** section in the **Diagnostics** page of the Control Panel.

The **Drop-Out Detection** section provides feedback on USB input/output and buffering errors. It has two displays and a button:

- **USB I/O Errors**: provides feedback on USB input/output errors. A high **USB I/O Errors** count points to your system being overloaded.

- **Buffer Underruns:** Buffer underruns occur when your computer isn't able to process an audio buffer in time. Reasons for underruns include too many ongoing background tasks or high CPU usage within a music program. Increasing the buffer size ([Process Buffer](#) parameter in the [Audio Processing](#) section of the [Audio Settings](#) page) will often prevent underruns.
- **Reset:** A click on this button resets the error count.

Connection Monitor Section

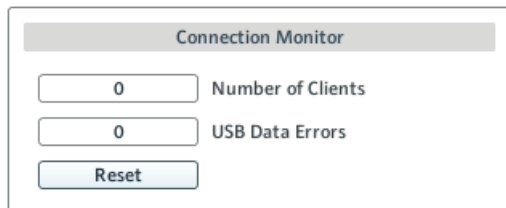

6.9 The [Connection Monitor](#) section in the [Diagnostics](#) page of the Control Panel.

The [Connection Monitor](#) section provides feedback on connected clients and USB data errors. It has two displays and a button:

- **Number of Clients:** displays the number of clients connected to the interface. Multiple ASIO applications are counted separately. WDM and WASAPI increase the number by one, no matter how many WDM / WASAPI applications play audio.
- **USB Data Errors:** counts USB data errors. Poor quality or long USB cables, as well as irradiation, can be the source of connection errors on the USB bus.
- **Reset:** A click on this button resets the error count.

System Performance Test Section

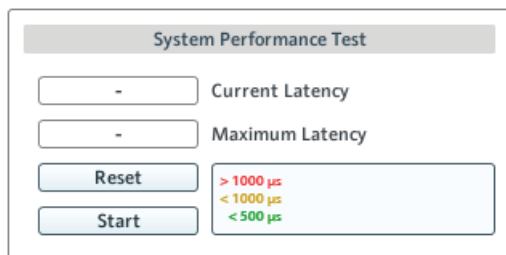

6.10 The [System Performance Test](#) section in the [Diagnostics](#) page of the Control Panel.

The [System Performance Test](#) section provides monitoring of the current DPC (Deferred Procedure Call) latency value of your Windows system. A Deferred Procedure Call is a Windows mechanism which allows high-priority tasks (such as the basic system tasks) to delay lower-priority tasks. This specific DPC latency is not to be confused with the overall latency, explained in chapter 10.1. The section has two displays and two buttons:

- **Current Latency:** displays the current DPC latency value.
- **Maximum Latency:** displays the highest DPC latency value monitored since the last time you either started or restarted monitoring.
- **Reset:** Press this button to reset the **Maximum Latency** value to zero.
- **Start/Stop:** Press this button to start monitoring DPC latency. Once started, the button label changes to **Stop**.

Information Section

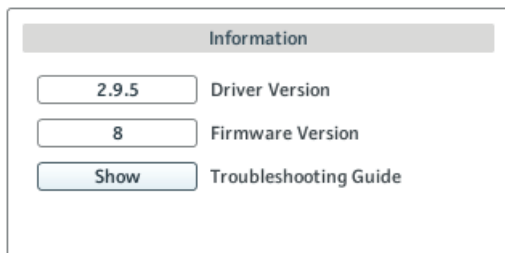

6.11 The **Information** section in the **Diagnostics** page of the Control Panel.

The **Information** section displays information about driver and firmware, and provides access to the Audio Troubleshooting Guide. This section has two displays and a button:

- **Driver Version:** See the currently installed driver version here.
- **Firmware Version:** See the currently installed firmware version here.
- **Troubleshooting Guide:** Click **Show** to open the Audio Troubleshooting Guide.

6.2 Advanced Configuration on Mac OS X

On Mac OS X, there are separate dialogs for configuring the TRAKTOR AUDIO 6 port settings and for configuring the interface's audio quality and MIDI settings:

- The channel configuration takes place in the Control Panel software (*Applications > Native Instruments > TRAKTOR AUDIO 6 Driver > TRAKTOR AUDIO 6 Control Panel*). Proceed with chapter 6.2.1
- The advanced audio and MIDI settings are accessed from the Mac OS X Audio MIDI Setup, located in the *Applications > Utilities* folder. Proceed with chapter 6.2.2.



If you experience problems with your setup, please refer to the Audio Troubleshooting Guide which you can access directly from the software's documentation folder.

6.2.1 Channel Setup (Port Configuration on Mac OS X)

The **Channel Setup** page in the Control Panel software allows you to configure the port settings (ports A and B) of your TRAKTOR AUDIO 6. Here you determine whether a port is set to amplify **Phono** or **Line** signal, and if the incoming signal should bypass internal processing by

your computer (**Direct Thru**) and be sent to its output channel immediately or not. Furthermore, you can choose between configuring a temporary (**Current**) and a default setting (**Startup**) for each port. To open the Control Panel, go to: *Applications > Native Instruments > TRAKTOR AUDIO 6 Driver > TRAKTOR AUDIO 6 Control Panel*.

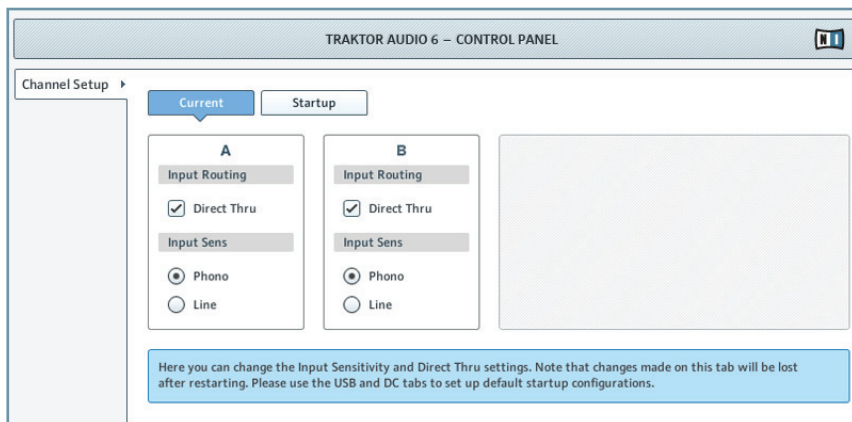

6.12 The Control Panel on Mac OS X

Port Options

The port configuration area of each port (A and B) contains two control sections: **Input Routing** and **Input Sens**:

- **Input Routing:**
 - Tick the **Direct Thru** checkbox if you want the incoming signal to bypass internal processing by your computer. This function is intended for **analog mixing** where you may want the incoming signal (e.g., when mixing in records from a turntable) to be sent directly from the port's input to the port's output channels. When using the soundcard for analog mixing in **stand-alone** mode (without a computer), **Direct Thru** has to be activated. See the Temporary and Default Settings subsection below for instructions on how to configure the soundcard's behavior on initial start up. Note, however, that you need a DC power supply to operate the soundcard in stand-alone mode. If you did not obtain the TA6 as part of a TRAKTOR software package, you can purchase the power supply separately from the NI webshop.
 - Deactivate the **Direct Thru** option for **digital mixing** (when using timecode vinyl or timecode CDs). The signal has to be sent through your computer for the timecode data to be processed by your DJ software.
- **Input Sens:**
 - Select **Phono** for when connecting a **turntable** to the port (no matter if digital mixing with timecode vinyl or analog mixing with records; both need phono amplification).
 - Select **Line** for when connecting a **CD deck** to the port (or other line level equipment such as a synthesizer, an MP3 player, a tapedeck, etc.).

Both ports A and B may be used by one of the following devices: a turntable with analog records, a turntable with timecode vinyl, a CD deck, a CD with a timecode disc, or any other line device.

 By default, the soundcard is set to **Phono** with activated **Direct Thru** mode on ports A and B for mixing analog signal from turntables.

Temporary and Default Settings (Current and Startup)

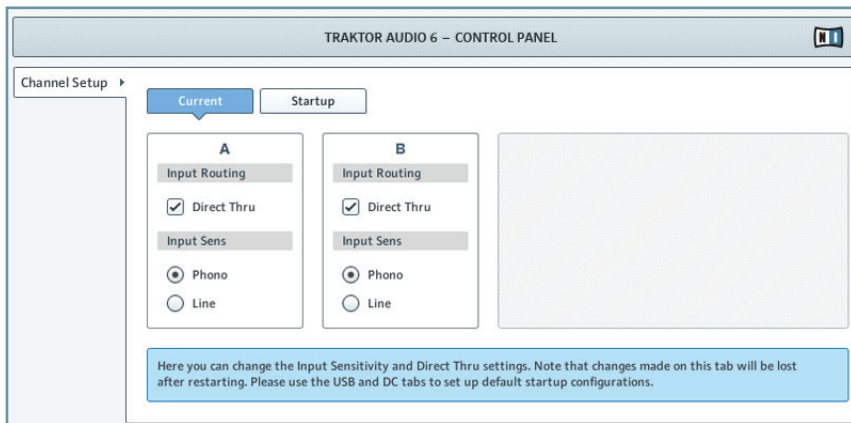

6.13 The Channel Setup with the **Current** settings tab selected.

The **Channel Setup** page holds two tabs for configuring the ports on your TRAKTOR AUDIO 6: the **Current** settings and the **Startup** settings tab:

- On initial start-up, the **Current** settings reflect the settings from the **Startup** settings tab (which holds the default settings). You can temporarily change these settings and they remain changed until the device becomes unplugged from the power source.

 When using a DC power supply (see also chapter 5.2), unplugging the USB cable does not affect the **Current** settings.

- The **Startup** settings tab holds the port settings that the soundcard defaults to when the device is initially plugged in with DC power (see also chapter 5.2 for more information on the power supply). To apply changes here, you first have to click on the lock symbol in the **Click the lock to make changes** dialog box. Confirm your changes by clicking the **Save** button.

 If you obtained the TA6 as part of a TRAKTOR software package, the power supply comes boxed with the soundcard. In case you bought the TA6 without TRAKTOR, there is no power supply boxed with the soundcard. The power supply is not mandatory for operating the soundcard, it is only needed for using the TA6 in stand-alone mode (see setup examples in chapter 7.1). You can purchase the power supply separately in the NI webshop.

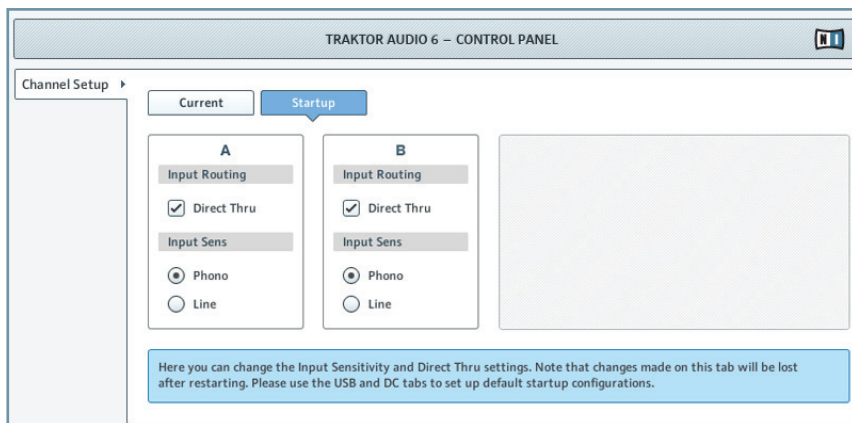

6.14 The Channel Setup with the **Startup** settings tab selected.



By default, the soundcard is set to **Phono** with activated **Direct Thru** mode on ports A and B for mixing analog signal from turntables.



If you want to use the TRAKTOR AUDIO 6 in stand-alone mode (without employing a computer), the **Startup** settings have to be set to **Direct Thru** on the relevant ports so the input channels forward the signal to the output channels. With **Direct Thru** deactivated, you will not hear any output on the relevant ports when running the soundcard in stand-alone mode.

6.2.2 Audio Configuration

To open the Audio MIDI Setup utility:

- ▶ Go to *Applications > Utilities > Audio MIDI Setup*.
- The Audio MIDI Setup utility will pop up in a window, entitled **Audio Devices**.

The left half of the window displays the different hardware and software in and outs installed on the computer. If not selected already, click on **Traktor Audio 6** to utilize the TRAKTOR AUDIO 6 device.

Input Pane

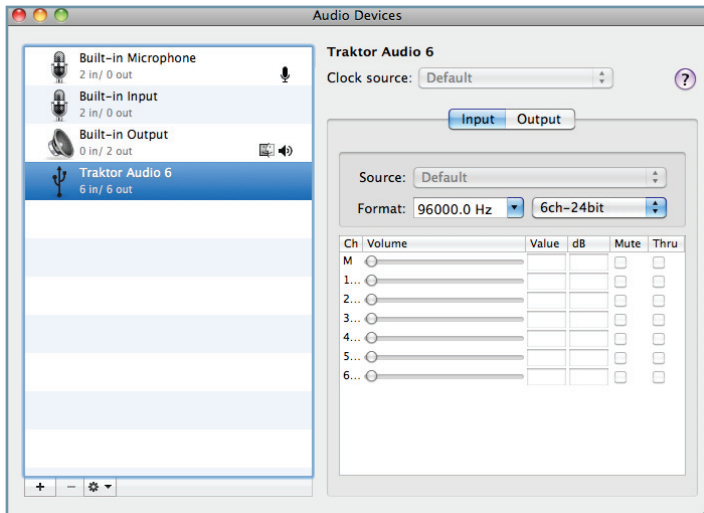

6.15 The **Input** pane of the Audio MIDI Setup utility in Mac OS X.

The Audio MIDI Setup's **Input** pane allows for selection of sample rate settings. The relevant element here is the **Format** drop-down menu.

- **Format:** Choose a sample rate that is compatible with your music application and suited to your computing power. A higher sample rate improves the audio quality but also causes higher CPU load.



The sample rate defines how many samples are played/recorded per one second of sound. A higher sample rate results in higher audio quality; however, 44100 Hz (as used for recording audio CDs) is a common setting and absolutely sufficient for most tasks. If your final destination is CD, use this setting or a multiple of it (88200 Hz). For a better understanding: 48000 Hz is used by DAT recorders and for DVD (films) recording. 96000 Hz and higher rates are typical for DVD, HD DVD, and Blu-ray Disc audio recording. Be aware that a higher sample rate also causes higher CPU load.

Output Pane

With the **Output** pane, you can modify the speaker configuration via the **Configure Speakers...** button. Please see your Mac OS X documentation for further instructions on this.

7 Using the TRAKTOR AUDIO 6 (Setup Scenarios)

This chapter covers possible TRAKTOR AUDIO 6 setup scenarios. Although we cannot cover all the potential setups here, the examples should be general enough for you to apply the information to your own individual use case.

- ❗ Make sure the TRAKTOR AUDIO 6 software is installed correctly and the interface is connected to your computer as described in chapter 3. Also make sure to have the soundcard set up as your computer's main audio output device (chapter 4) before you proceed with the setups.

7.1 Analog DJing Setups

In this chapter, you'll find instructions on how to set up the TRAKTOR AUDIO 6 for analog DJing with a turntable / CD deck.

7.1.1 Connecting a Turntable for Analog DJing

- ❗ The example given shows the use of the TA6 as a stand-alone device, i.e., without employing a computer. For use as a stand-alone device, the soundcard needs to be powered by a DC power supply. In case you did not obtain the TA6 as a part of a TRAKTOR software package, you can purchase the power supply separately in the NI webshop. Note, however, that the setups in this chapter also work when powering the soundcard via USB instead of using a power supply.

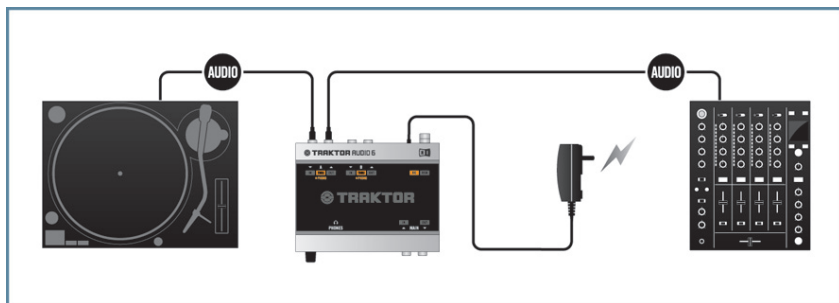

7.1 TRAKTOR AUDIO 6 in an analog DJing setup with a turntable and a mixer.

- ❗ The example in this chapter shows how to use the soundcard for analog DJing in stand-alone mode (without employing a computer). Note, however, that the relevant ports have to be set to **Phono** and **Direct Thru** in the **Startup** tab of the Control Panel's **Channel Setup** page. For instructions on configuring the ports, please read chapter 6.1.2 / 6.2.1.

- 💡 Note that you can combine analog with digital DJing in one setup, i.e., mixing in a record on one port while playing music from your computer on another. For instructions on configuring the ports, please read chapter 6.1.2 / 6.2.1.

To use your TRAKTOR AUDIO 6 in an analog DJing setup with a turntable and a mixer:

1. Connect the OUT channel of a port on the rear panel of the TA6 to a Line/CD input channel on your mixer. Use a stereo RCA (phono) cable.

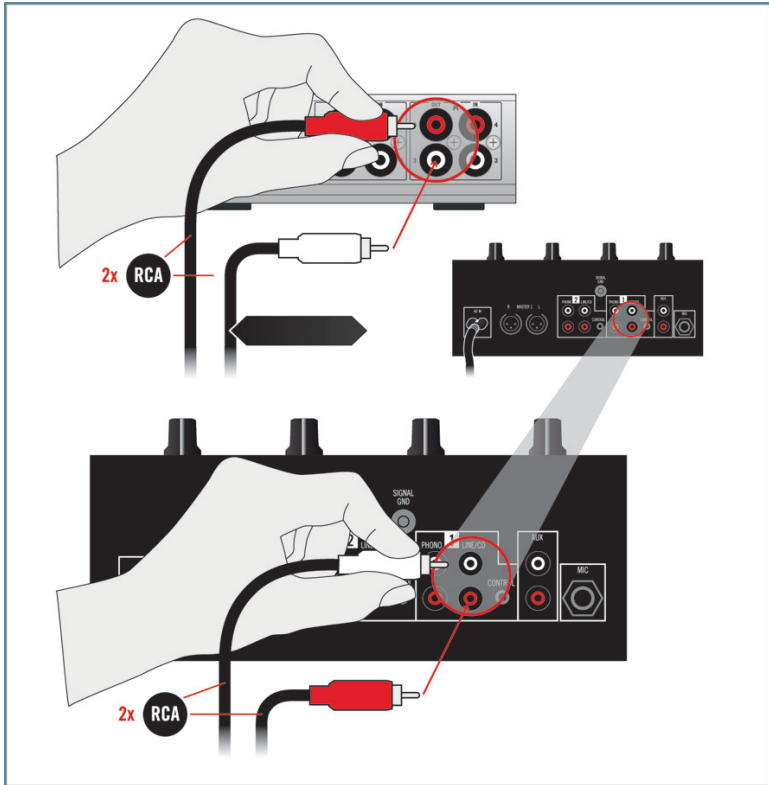

2. Set the channel volume on your mixer to minimum.

3. Connect the IN channel of the same port on the TA6 to your turntable with a stereo RCA (phono) cable.

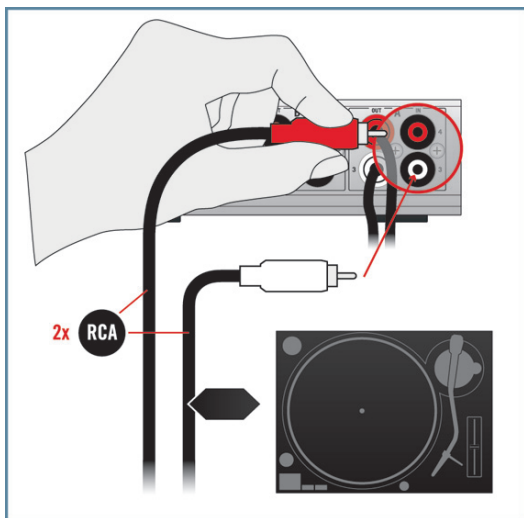

4. Attach the ground wire of your turntable to the ground post of your mixer (alternatively, you can attach it to the ground post on the rear panel of the TA6).

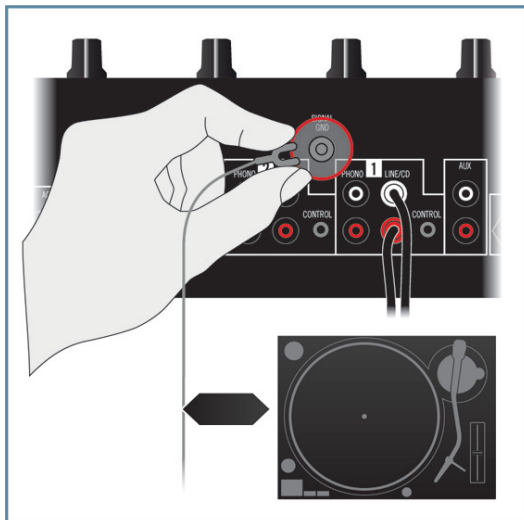

5. Make sure the selected port on the TA6 is set to PHONO and THRU (see soundcard's top panel LEDs). The port configuration takes place in the Control Panel software with the TA6 connected to your computer. For more information on how to configure the ports, please read chapter 6.1.2 / 6.2.1.



6. Start the playback of a record on your turntable.
7. Gradually raise the volume of the selected mixer channel until you reach a good listening level.

7.1.2 Connecting a CD Deck for Analog DJing

- ! The example given shows the use of the TA6 as a stand-alone device, i.e., without employing a computer. For use as a stand-alone device, the soundcard needs to be powered by a DC power supply. In case you didn't obtain the TA6 as a part of a TRAKTOR software package, you can purchase the power supply separately in the NI webshop. Note, however, that the setups in this chapter also work when powering the soundcard via USB instead of using a power supply.

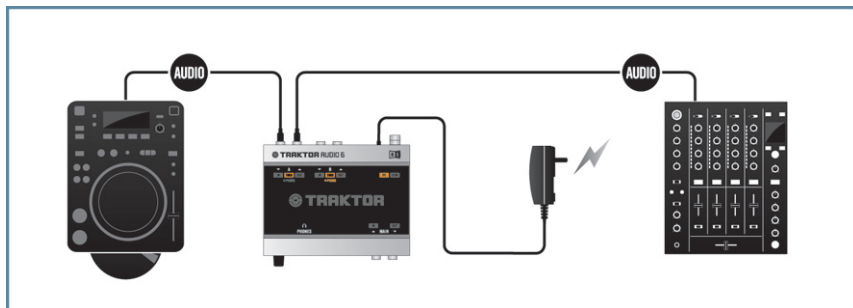

7.2 TRAKTOR AUDIO 6 in an analog DJing setup with a CD deck and a mixer.

- ! The example in this chapter shows how to use the soundcard for analog DJing in stand-alone mode (without employing a computer). Note, however, that the relevant ports have to be set to **Line** and **Direct Thru** in the **Startup** tab of the Control Panel's **Channel Setup** page in order for stand-alone mode to work. For instructions on configuring the ports, please read chapter 6.1.2 / 6.2.1.
- 💡 Note that you can combine analog with digital DJing in one setup, i.e., mixing in a CD deck output on one port while playing music from your computer on another. For instructions on configuring the ports, please read chapter 6.1.2 / 6.2.1.

To use your TRAKTOR AUDIO 6 in an analog DJing setup with a CD deck and a mixer:

1. Connect the OUT channel of a port on the rear panel of the TA6 to a Line/CD input channel on your mixer. Use a stereo RCA (phono) cable.

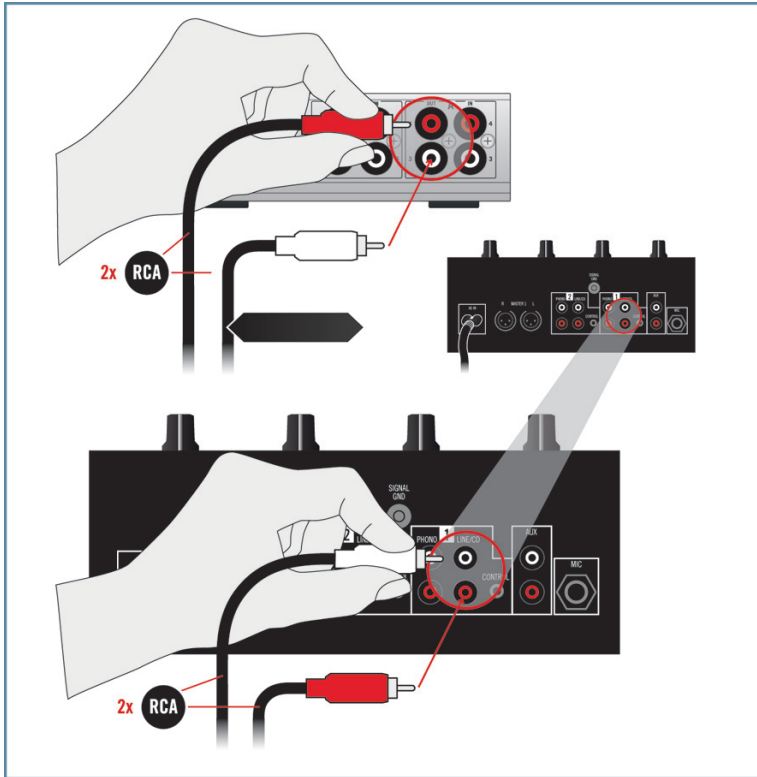

2. Set the channel volume on your mixer to minimum.

3. Connect the input channel of the same port on the TA6 to your CD deck with a stereo RCA (phono) cable.

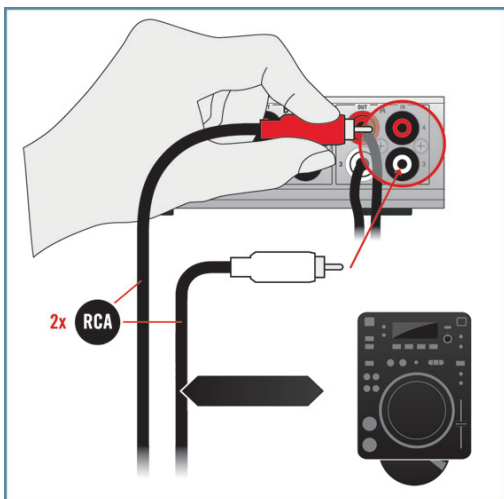

4. Make sure the selected port on the TA6 is set to LINE and THRU (see soundcard's top panel LEDs). The port configuration takes place in the Control Panel software with the TA6 connected to your computer. For more information on how to configure the ports, please read chapter 6.1.2 / 6.2.1.



5. Start the playback of a CD in your CD deck.
6. Gradually raise the volume of the selected mixer channel until you reach a good listening level.

7.2 Digital DJing Setups

7.2.1 Setting Up TRAKTOR AUDIO 6 for Internal Mixing

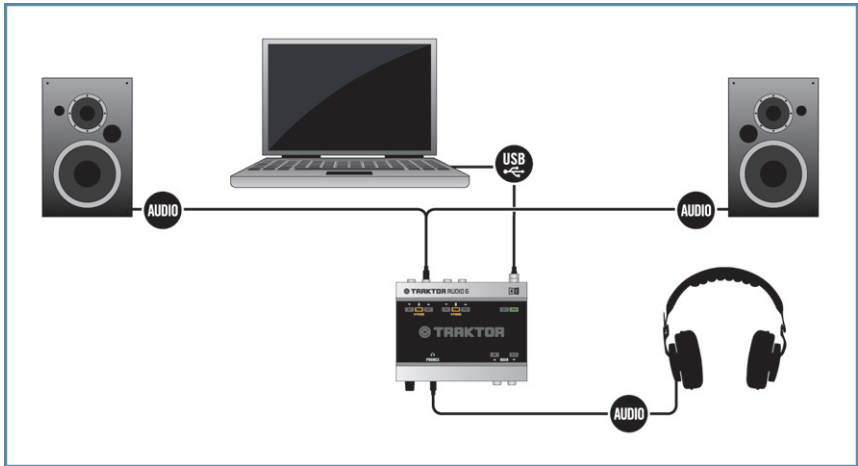

7.3 TRAKTOR AUDIO 6 in a digital DJing setup with a DJing software and internal mixing.

- !** Make sure the TRAKTOR AUDIO 6 software is installed correctly and the interface is connected to your computer as described in chapter 3. Also make sure to have the soundcard set up as your computer's main audio output device (chapter 4) before you proceed with the setups.

To use your TRAKTOR AUDIO 6 in a digital DJing setup with a DJing software and internal mixing:

1. Plug the 1/4" TRS jack of your headphones into the MAIN phones socket on the TA6's front panel. Turn the Headphone Volume Control knob (VOLUME) to the left-end stop to set the volume to minimum.

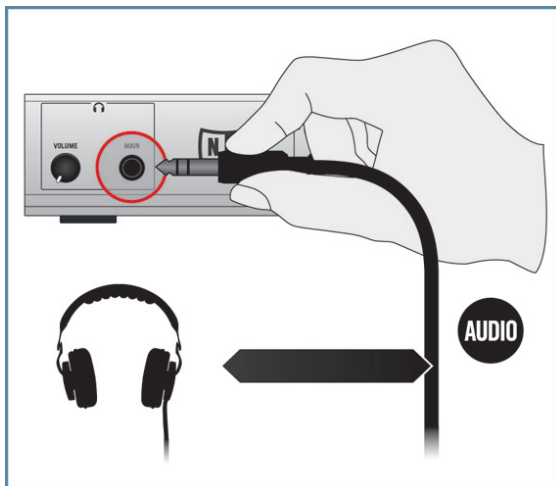

2. Set the volume on your active speakers / stereo amplifier to minimum.

3. Connect the OUT channel of a selected port on the rear panel of the TA6 (the port your DJ software outputs audio through) to your active speakers / stereo amplifier. Use a stereo RCA (phono) cable. In case your active speakers have 1/4" or XLR sockets, use RCA adapter cables to connect them to the TA6.

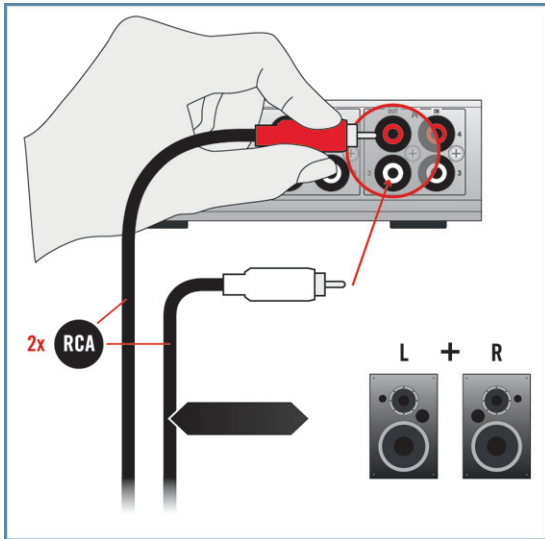

4. Start the playback of a track in your DJing software.
5. Gradually raise the volume on your active speakers / stereo amplifier until you reach a good listening level.



For information on how to configure your DJ software, please refer to your software's documentation.

7.2.2 Setting Up TRAKTOR AUDIO 6 for External Mixing

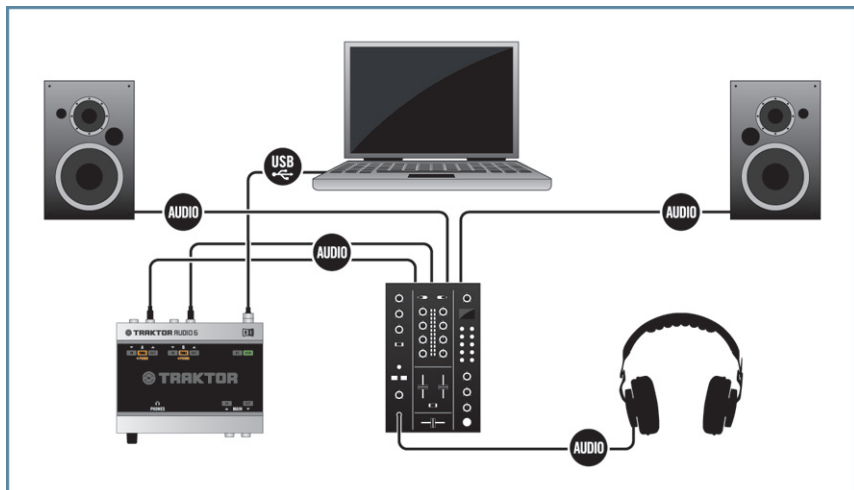

7.4 TRAKTOR AUDIO 6 in a digital DJing setup with a DJing software and an external mixer.



Make sure the TRAKTOR AUDIO 6 software is installed correctly and the interface is connected to your computer as described in chapter 3. Also make sure to have the soundcard set up as your computer's main audio output device (chapter 4) before you proceed with the setups.

To use your TRAKTOR AUDIO 6 in a digital DJing setup with a DJing software and an external mixer:

1. Set the volume for all channels of your mixer, and the headphone output volume of your mixer to minimum.

2. Connect the OUT channel of a port on the rear panel of the TA6 to a Line/CD input channel of your mixer. Use a stereo RCA (phono) cable. Make sure the selected channel on the TA6 is assigned to an output channel of your DJ software.

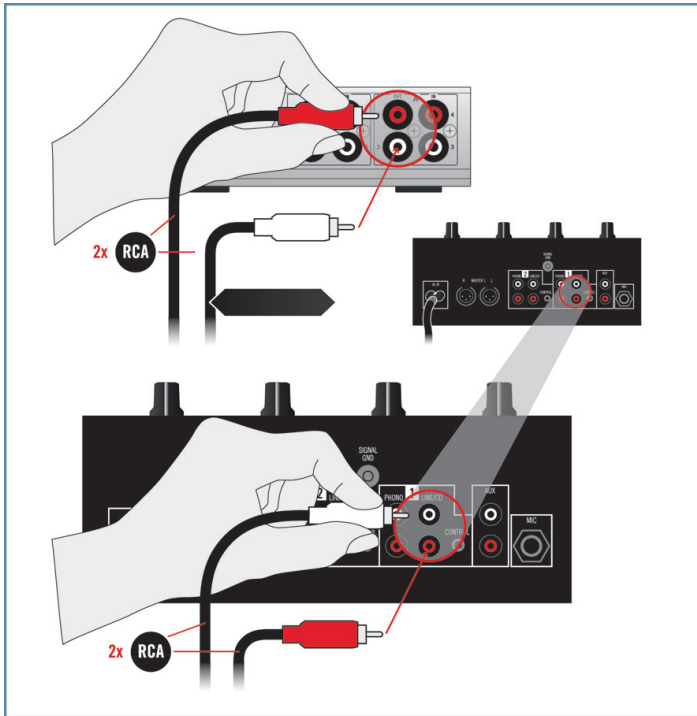

3. Connect the OUT channel of the second port on the TA6 to another Line/CD input channel of your mixer. Make sure the selected channel on the TA6 is assigned to an output channel of your DJ software.

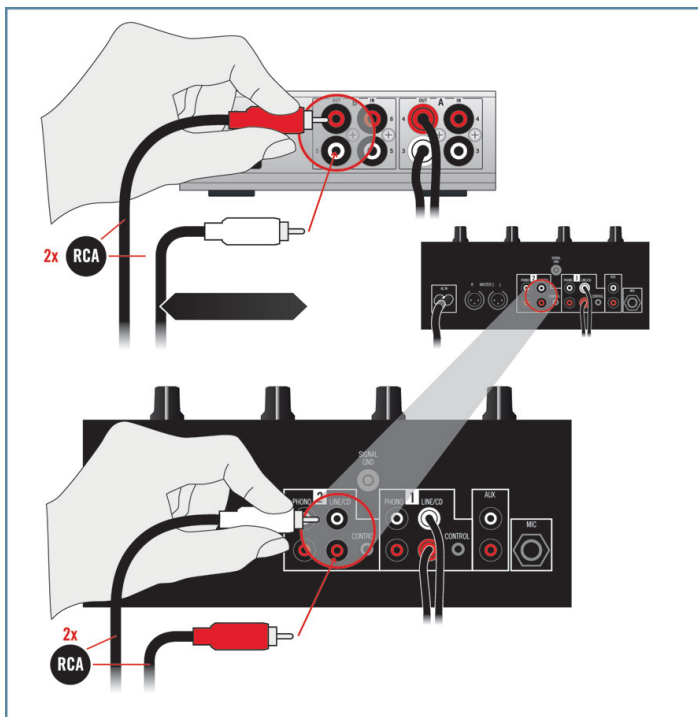

4. Connect your headphones to the headphone output of your mixer.

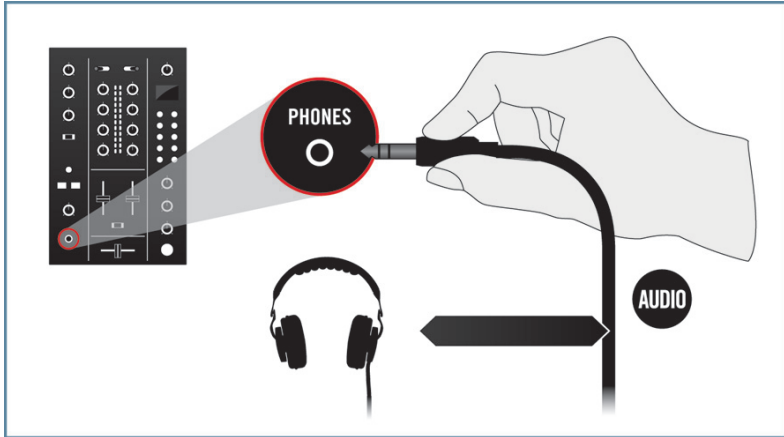

5. Connect the main outputs of your mixer to your active speakers / stereo amplifier.

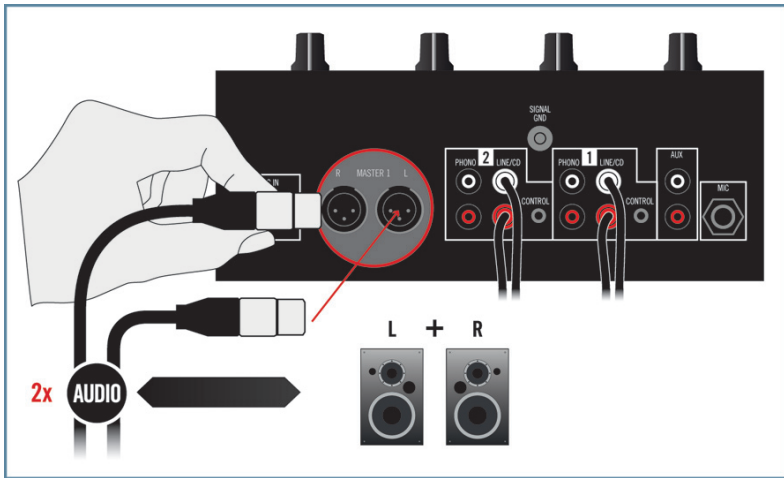

6. Start the playback of a track in your DJ software.
7. Gradually raise the channel and headphones volume on your mixer until you reach a good listening level.

! For information on how to configure your DJ software, please refer to your software's documentation.

7.2.3 Connecting Turntables for DJing with Timecode Vinyl

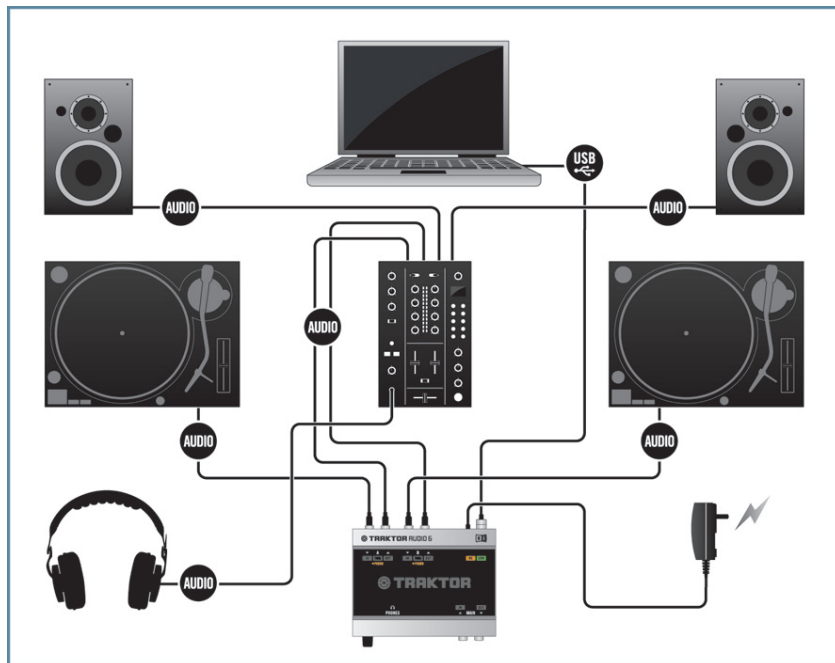

7.5 TRAKTOR AUDIO 6 in a digital DJing setup with a DJing software, turntables with timecode vinyl, and an external mixer.

! Make sure the TRAKTOR AUDIO 6 software is installed correctly and the interface is connected to your computer as described in chapter 3. Also make sure to have the soundcard set up as your computer's main audio output device (chapter 4) before you proceed with the setups.

! The DC power supply is not mandatory for operating the soundcard, it is only needed for using the TA6 in stand-alone mode (without employing a computer).

To use your TRAKTOR AUDIO 6 in a digital DJing setup with DJing software, turntables with timecode vinyl, and an external mixer:

1. Set the volume for all channels of your mixer, and the headphone output volume of your mixer, to minimum.

2. Connect the OUT channel of a port on the rear panel of the TA6 to a Line/CD input channel of your mixer. Use a stereo RCA (phono) cable.

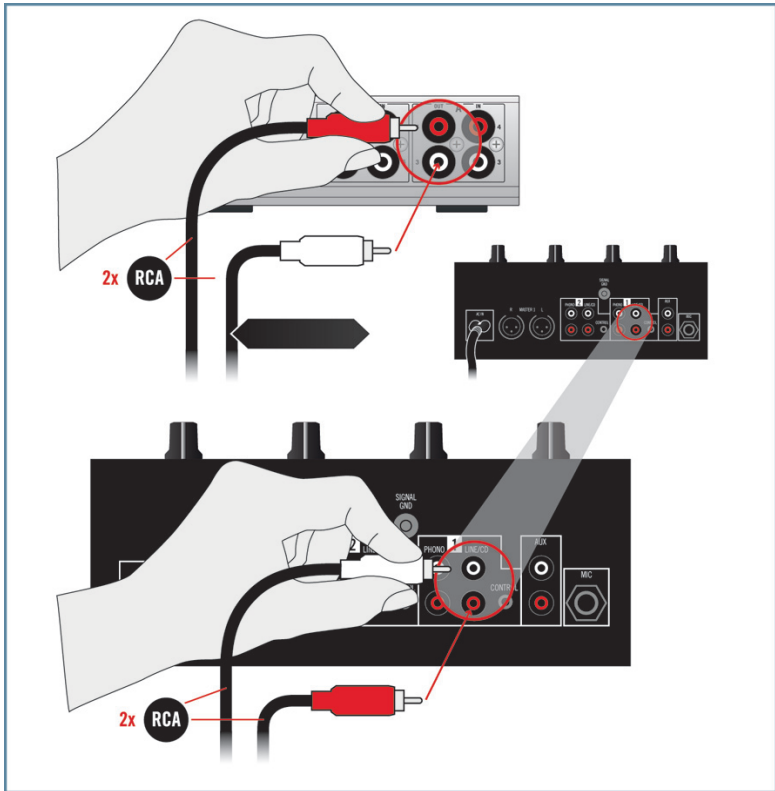

3. Connect the IN channel of the same port on the TA6 to your first turntable with a stereo RCA (phono) cable.

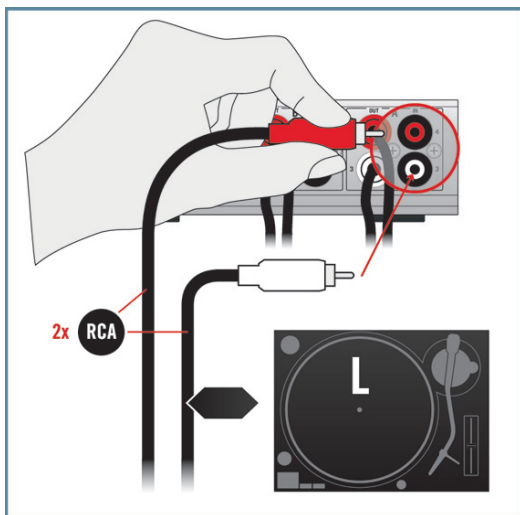

4. Attach the ground wire of your first turntable to a ground post on your mixer (alternatively, you can attach it to the ground post on the rear panel of the TA6).

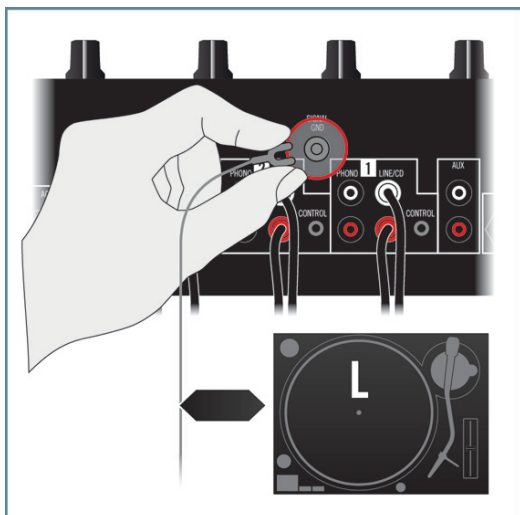

5. Connect the OUT channel of the second port on the TA6 to another Line/CD input channel of your mixer.

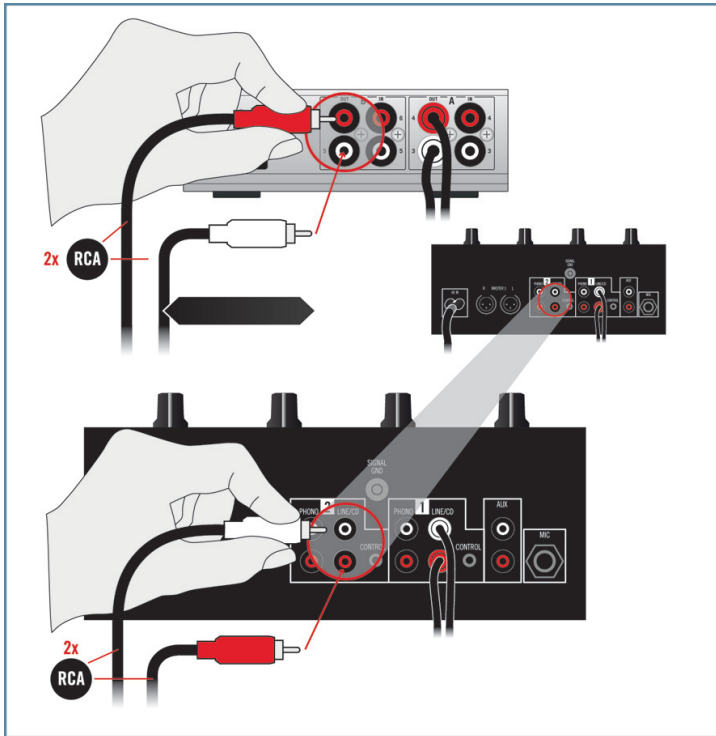

6. Connect the IN channel of that second port on the TA6 to your second turntable with a stereo RCA (phono) cable.

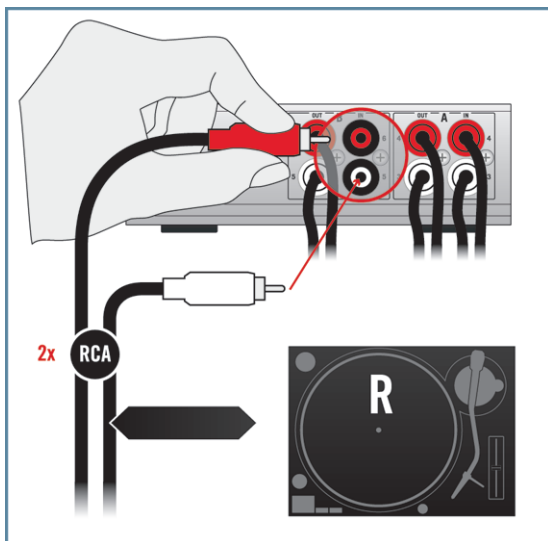

7. Attach the ground wire of your second turntable to the ground post of your mixer (alternatively, you can attach it to the ground post on the rear panel of the TA6).

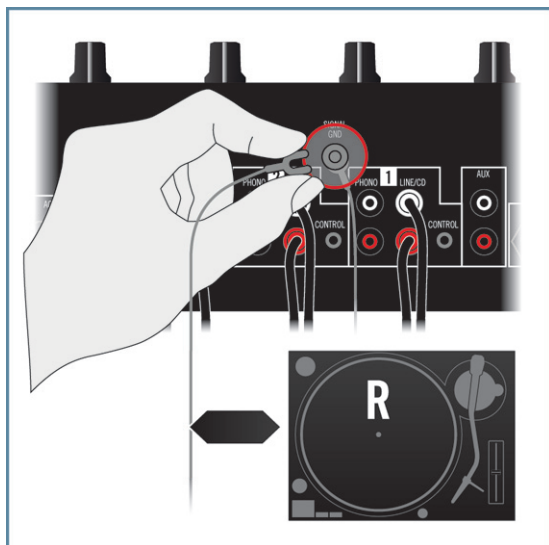

- Make sure your selected ports on the TA6 are set to PHONO, and THRU mode is **deactivated** (see soundcard's top panel LEDs). For configuring the ports, use the Control Panel software, which was installed during the software installation process in chapter 3.2. For instructions on how to open the Control Panel and configure the ports, please read chapter 6.1.2 / 6.2.1.



- Connect your headphones to the headphone output of your mixer.

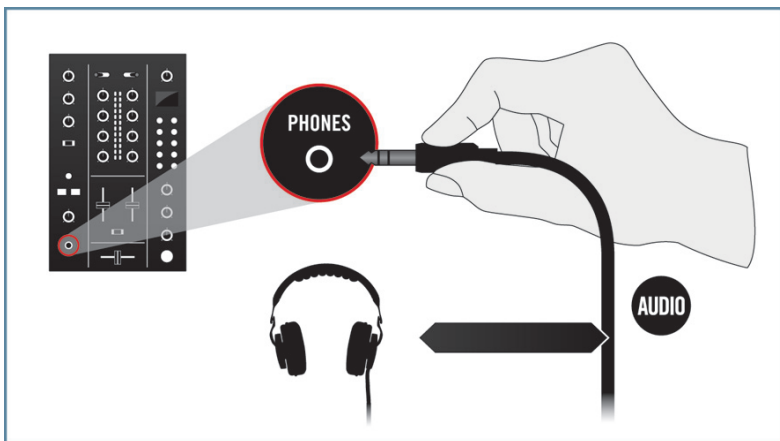

10. Connect the main outputs of your mixer to your active speakers / stereo amplifier.

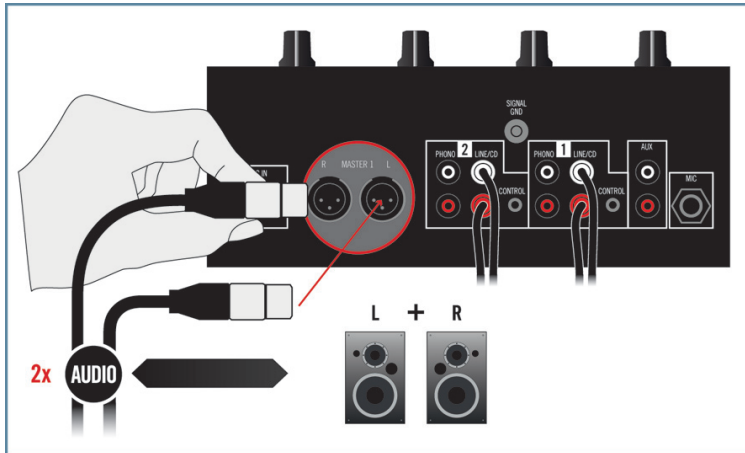

11. Start the playback of a track in your DJing software via timecode on the turntable.
12. Gradually raise the volume of the mixer channels and the headphones output volume on your mixer until you reach a good listening level.

! Make sure that the output channels on the TA6 are assigned to the proper output channels in your DJ software. For information on how to configure your DJ software, please refer to your software's documentation.

7.2.4 Connecting CD Decks for DJing with Timecode CDs

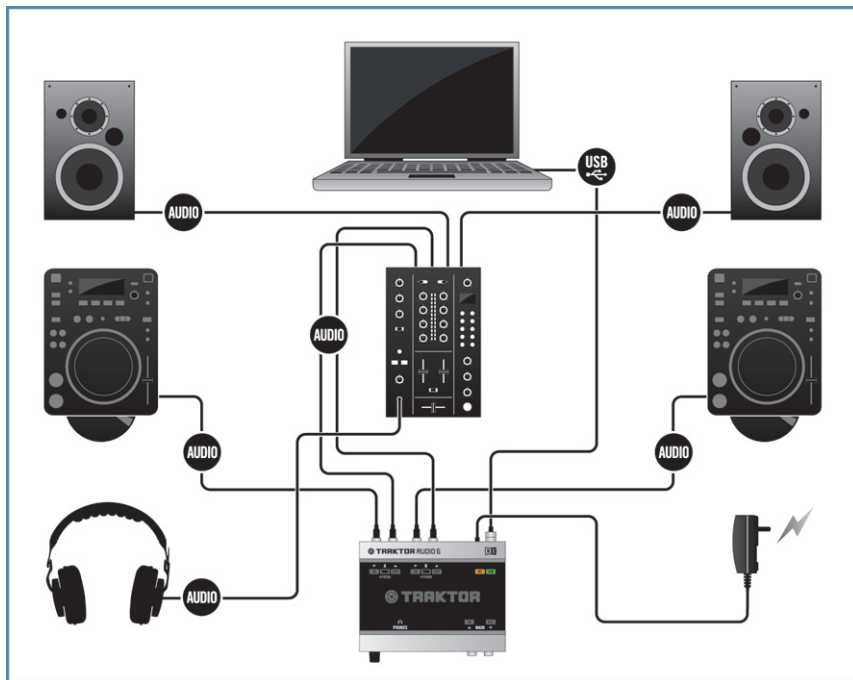

7.6 TRAKTOR AUDIO 6 in a digital DJing setup with a DJing software, CD decks with timecode CDs, and an external mixer.

! Make sure the TRAKTOR AUDIO 6 software is installed correctly and the interface is connected to your computer as described in chapter 3. Also make sure to have the soundcard set up as your computer's main audio output device (chapter 4) before you proceed with the setups.

! The DC power supply is not mandatory for operating the soundcard, it is only needed for using the TA6 in stand-alone mode (without employing a computer).

To use your TRAKTOR AUDIO 6 in a digital DJing setup with DJing software, CD decks with timecode CDs, and an external mixer:

1. Set the volume for all channels of your mixer, and the headphone output volume of your mixer, to minimum.

2. Connect the OUT channel of a port on the rear panel of the TA6 to a Line/CD input channel of your mixer. Use a stereo RCA (phono) cable.

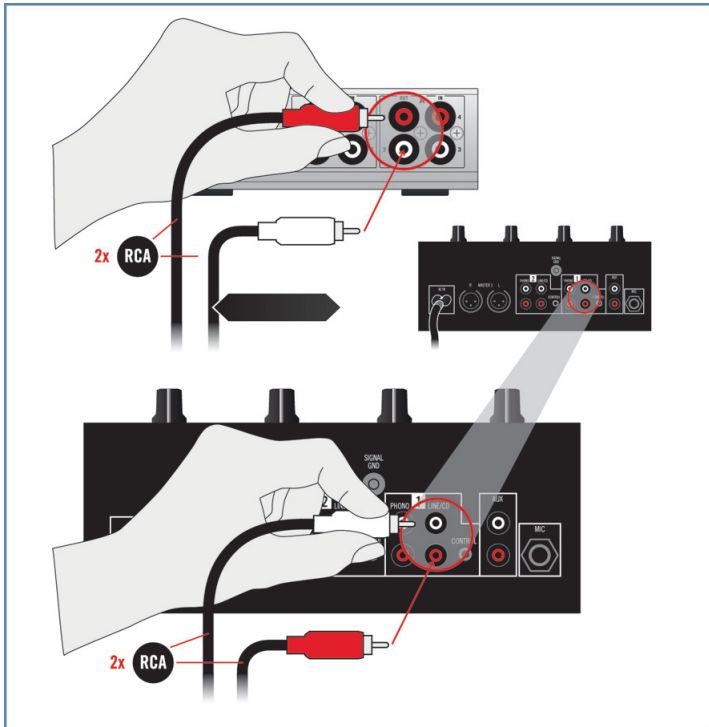

3. Connect the IN channel of the same port on the TA6 to your first CD deck with a stereo RCA (phono) cable.

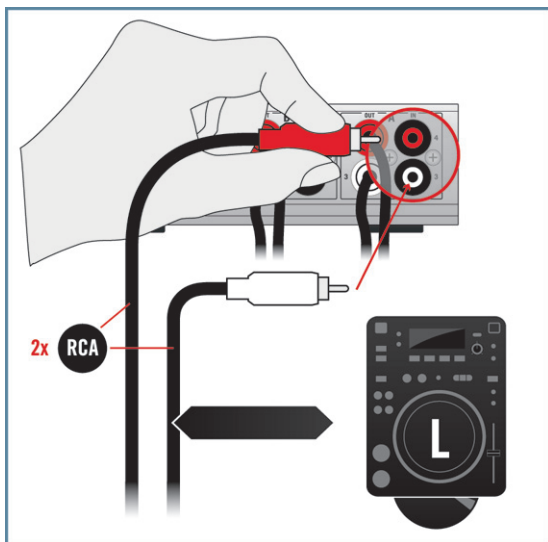

4. Connect the OUT channel of the second port on the TA6 to another Line/CD input channel of your mixer.

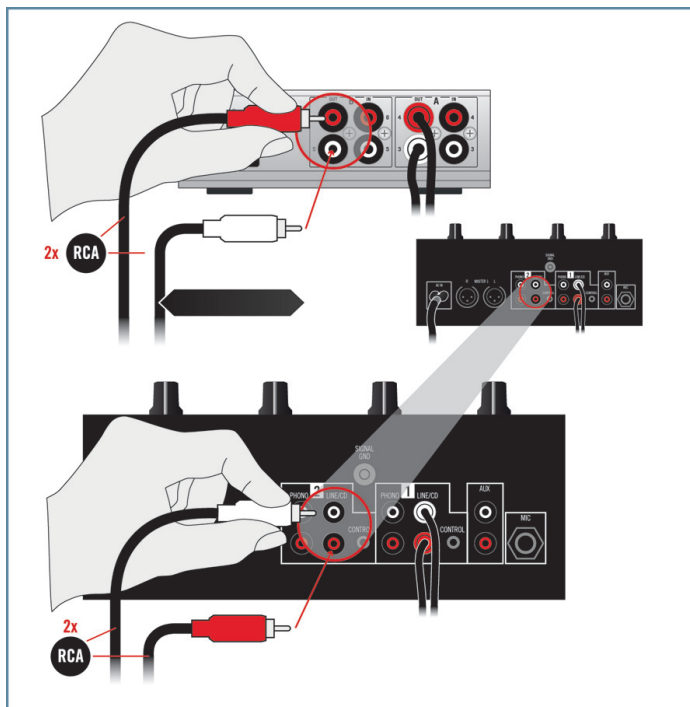

5. Connect the IN channel of that second port on the TA6 to your second CD deck with a stereo RCA (phono) cable.

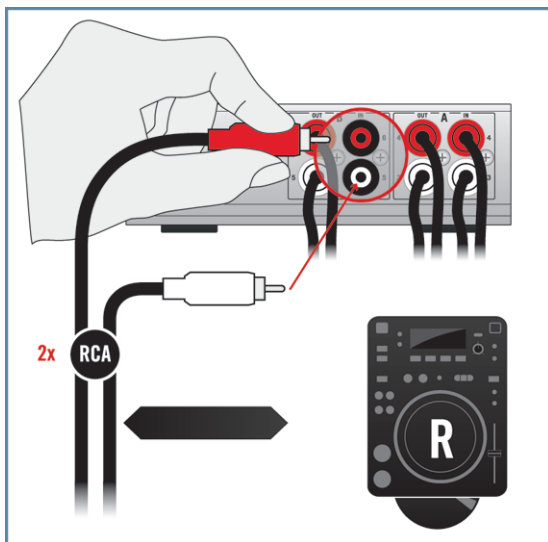

6. Make sure your selected ports on the TA6 are set to LINE (so the PHONO LED does not light on the top panel), and THRU mode is **deactivated** (also see soundcard's top panel LEDs). For configuring the ports, use the Control Panel software which was installed during the software installation process in chapter 3.2. For instructions on how to open the Control Panel and configure the ports, please read chapter 6.1.2 / 6.2.1.



7. Connect your headphones to the headphone output of your mixer.

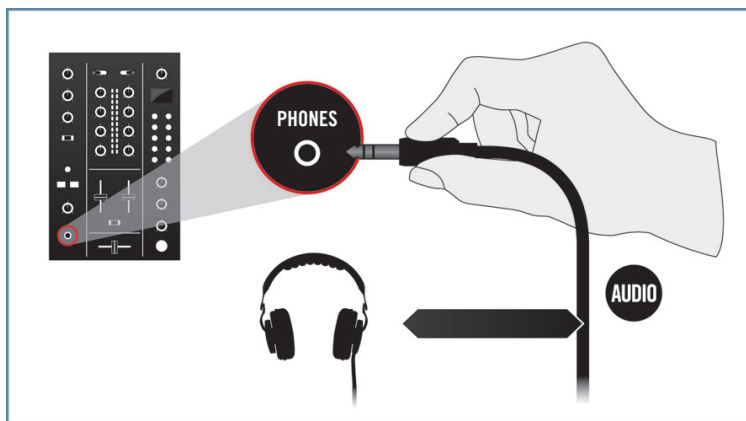

8. Connect the main outputs of your mixer to your active speakers / stereo amplifier.

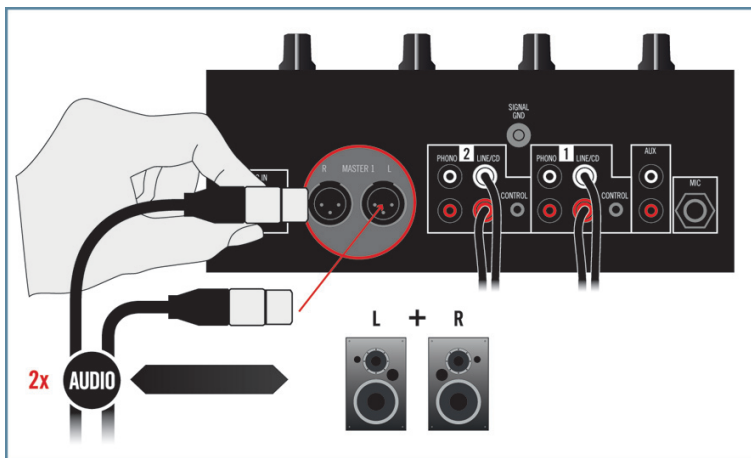

9. Start the playback of a track in your DJing software via timecode on the CD deck.
10. Gradually raise the volume of the mixer channels and the headphones output volume on your mixer until you reach a good listening level.



Make sure that the output channels on the TA6 are assigned to the proper output channels in your DJ software. For information on how to configure your DJ software, please refer to your software's documentation.

7.3 Miscellaneous Setups

7.3.1 Connecting Headphones

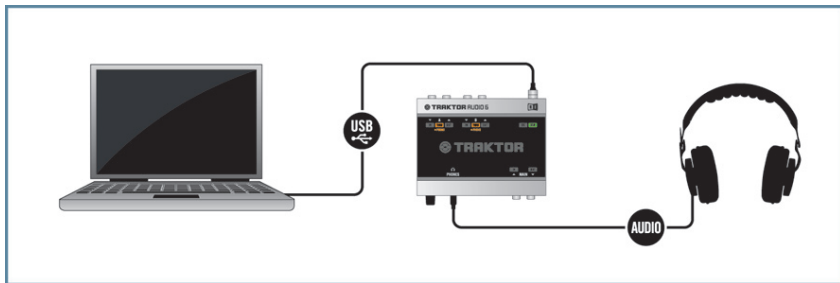

7.7 TRAKTOR AUDIO 6 in a setup with a computer and headphones.

! Make sure the TRAKTOR AUDIO 6 software is installed correctly and the interface is connected to your computer as described in chapter 3. Also make sure to have the soundcard set up as your computer's main audio output device (chapter 4) before you proceed with the setups.

To use your TRAKTOR AUDIO 6 in a setup with a computer and headphones:

1. Plug the 1/4" TRS jack of your headphones into the MAIN phones socket on the TA6's front panel. Turn the Headphone Volume Control knob (VOLUME) to the left-<end stop to set the volume to minimum.

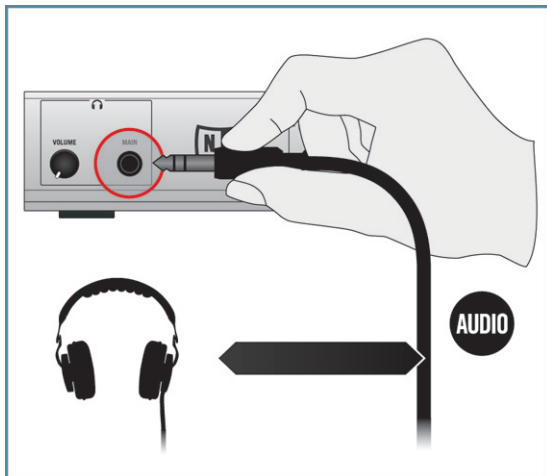

2. Start the playback of an audio file on your computer.
3. Gradually turn the Headphone Volume Control knob (VOLUME) of the TA6 to the right until you reach a good listening level.

8 Troubleshooting

The information provided in this chapter should help you to solve most of the problems you may encounter while you are using the TRAKTOR AUDIO 6.

8.1 Solving Hardware-related Problems

All Native Instruments products are extensively tested in real life situations during the development phase. However, if you encounter any problems with your hardware, please check the following points:

- Verify that you have installed the latest driver and the latest software update. Check the Native Instruments website for further information.
- Make sure the TRAKTOR AUDIO 6 interface is connected to a USB 2.0 port on your computer (see also 8.3).
- Make sure the TRAKTOR AUDIO 6 is connected directly to a USB port of the computer and not through a USB hub (see also 8.3).
- Try changing out the USB cable (see also 8.3).
- Disconnect all other USB devices from the computer (except keyboard/mouse).
- Try using another USB port on your computer (see also 8.3).

If none of these tips help, please contact our Technical Support team. The contact information is available under the following URL: <http://www.native-instruments.com/contactinfo>. In case the TRAKTOR AUDIO 6 needs to be returned, the Technical Support team at Native Instruments will assign you an **RA (Return Authorization)** number, which is required to handle your return. Packages returned without this RA number will not be correctly identified and as such might not be processed properly.

8.2 How to Check Whether the TRAKTOR AUDIO 6 Drivers are Installed Correctly

Windows

Open *Start > All Programs > Native Instruments > TRAKTOR AUDIO 6 Driver*. There you will find the helper application Control Panel. Make sure that the device is connected to the computer and open the Control Panel. If all the drop-down menus are grayed out (i.e., there are no presets in the preset drop-down list and no sample rate values to choose from) there must be something wrong with the connection. If the *TRAKTOR AUDIO 6 Driver* entry in the Native Instruments folder of the Start Menu is missing, the driver is most probably not installed.

- If the driver is not installed, you can install it as described in chapter 3.
- If the driver is not recognized, check your USB 2.0 connection as described in chapter 8.3.

- As any other USB device, the driver installs exactly for one USB port. If you connect the TRAKTOR AUDIO 6 to another port, a standard Windows dialog opens in which you can install the driver to that port. If you have previously installed the driver on your computer once, Windows will find the right drivers itself once that you start the driver installation procedure. If you cancel the installation procedure, the driver will not be installed and the interface will not work on that port.
- If you do not know whether drivers were installed correctly, it is advisable to start the setup program of the TRAKTOR AUDIO 6 again (see chapter 3). If the setup program states that it will first uninstall the drivers, you already have installed the drivers on your computer. In this case you can connect the device to any other USB port and Windows will find the right driver when installing the TRAKTOR AUDIO 6 on another USB port.

Mac OS X

On Mac OS X, open the System Preferences for the Native Instruments USB Audio Control Panel icon. Open the control panel to see whether the device is detected.

- If the device is not detected, values will appear grayed out. If the Native Instruments USB Audio Control Panel icon is missing here, the driver is probably not installed.
- If the driver is not installed, you can install it as described in chapter 2.
- If the driver is not recognized, check your USB 2.0 connection as described in chapter 8.3.

8.3 USB Troubleshooting

If you experience problems caused by the USB connection between the TRAKTOR AUDIO 6 and your computer, check the following chapters first; several possible sources for USB issues are covered here.

8.3.1 USB 2.0 required

The TRAKTOR AUDIO 6 is a USB 2.0 interface and will not work at all on a USB 1.0/1.1 port.

8.3.2 Try another USB cable

A bad USB cable can be responsible for audio dropouts and other connectivity problems. It is recommended that you try using a different cable if you experience difficulties. Also, make sure to use a cable bearing the official USB logo.

8.3.3 Using a powered USB 2.0 hub

Connect the TRAKTOR AUDIO 6 to a USB 2.0 port directly on your computer. In certain situations, a powered USB hub may also work (e.g., if you are having problems connecting your TRAKTOR AUDIO 6 to an onboard USB port).

8.3.4 Recommended USB-ports (MacBook Only)

For a current list of recommended ports on Mac Laptops (MacBook and MacBook Pro). Please refer to our knowledge base article <http://www.native-instruments.com/knowledge/questions/263>.

8.3.5 Disable USB Energy Saving Mode (Windows only)

If the TRAKTOR AUDIO 6 is causing crashes or performing badly on a Windows machine, disable power management to the USB hubs first; see the Windows documentation for further instructions.

8.3.6 Update the Driver

Whenever you encounter problems, you should also check if you have the latest software installed. For updates, visit the product's homepage on our website <http://www.native-instruments.com>.

8.4 Physically Re-configuring the TRAKTOR AUDIO 6

Connect the TRAKTOR AUDIO 6 to another USB port on your computer. Try all USB ports on your computer until you find the one that works best.

8.5 Check your IRQs (Windows only)

IRQ stands for Interrupt Request. This is the way in which Windows allocates resources to the various devices and ports in your system. If your TRAKTOR AUDIO 6 is on a port that shares an IRQ with other devices, you may have an IRQ conflict. Please refer to the Knowledge Base on the Native Instruments website and contact support.

9 Getting Help

Native Instruments provides various sources of support and information to registered users.

9.1 Readme / Knowledge Base / Technical Support

Readme

Always read the “Readme” file found on the installation CD. It contains important information and all last minute changes that could not be included in this manual.

Knowledge Base

Access the Knowledge Base at <http://www.native-instruments.com/knowledgebase>. To search the Knowledge Base, log into your user account first. For information on registering a user account, see chapter 3.4.

Technical Support

You can reach the Technical Support team online via <http://www.native-instruments.com> > Support > Product Support. The subsequent form will ask you for all information about your hardware and software environment to better facilitate our support team. In your communication with the support team, you should offer as much information as possible; about your hardware, your operating system, and the software you are running. In your description, you should mention:

- How to reproduce the problem
- What you have already done to try to fix the problem
- A description of your setup, including all hardware and software involved
- The exact model and technical specifications of your computer

9.2 Forum

Check out the NI TRAKTOR and the NI producer forum to discuss all aspects of TRAKTOR AUDIO 6 and TRAKTOR LE with other users: <http://www.native-instruments.com/djforums> and <http://www.native-instruments.com/forum/>.

9.3 Updates

Whenever you encounter problems, you should also check if you have the latest software installed. For updates, visit the product’s homepage on our website: <http://www.native-instruments.com>.

10 Appendix

10.1 About Latency and Buffers

When converting audio information to digital and vice versa, the audio driver needs to store the data in buffer packages (audio buffers) which are then sent to and processed by the CPU of your computer. The higher the buffer size, the longer it takes for a signal to finally arrive at the output as audio. You might experience this as late response between hitting a key on a controller which controls music software on your computer and hearing the sound at the output. Fortunately, with today's computers and low-latency sound card drivers, this delay is usually very low (e.g., three milliseconds is about the same delay caused by fingers snapping one meter away from your ears). Latency must be kept at minimum in order to make software instruments and DJ applications playable.

How Low Can You Go?

1.5 ms of latency approaches the theoretical minimum because it will always take some time to process information in a computer. Note that ultra-low buffer size settings (as well as higher sample rates) make your computer work harder, which can adversely affect the performance.

Read chapter 6 for instructions on how to adjust buffer sizes and sample rates for shorter latency.



If you cannot get rid of audio dropouts, crackles, and noises by adjusting buffer size and sample rate settings, check your system using the DPC Latency Checker Program for Windows, found on the web at http://www.thesycon.de/eng/latency_check.shtml.

10.2 Different Types of ASIO

It is extremely important to use the dedicated ASIO driver written for the TRAKTOR AUDIO 6 and installed during software installation (chapter 3) of the TRAKTOR AUDIO 6. There are also generic ASIO drivers (for Windows), typically called ASIO DirectX Full Duplex Driver or ASIO Multimedia Driver. If you're not sure which one to use, try them all and choose the one that provides the lowest latency.

The information in this document is subject to change without notice and does not represent a commitment on the part of Native Instruments GmbH. The software described by this document is subject to a License Agreement and may not be copied to other media. No part of this publication may be copied, reproduced or otherwise transmitted or recorded, for any purpose, without prior written permission by Native Instruments GmbH, hereinafter referred to as Native Instruments.

“Native Instruments”, “NI” and associated logos are (registered) trademarks of Native Instruments GmbH.

Mac, Mac OS, GarageBand, Logic, iTunes and iPod are registered trademarks of Apple Inc., registered in the U.S. and other countries.

Windows, Windows Vista and DirectSound are registered trademarks of Microsoft Corporation in the United States and/or other countries.

Intel and Pentium are registered trademarks of Intel Corporation in the United States and other countries.

Cirrus Logic is a trademark of Cirrus Logic, Inc.

XMOS is a trademark of Xmos Ltd., UK.

All other trade marks are the property of their respective owners and use of them does not imply any affiliation with or endorsement by them.

© 2011, Native Instruments GmbH. All rights reserved.



THE FUTURE OF SOUND

Native Instruments GmbH

Schlesische Straße 29-30 | 10997 Berlin | Germany

www.native-instruments.de

Native Instruments North America, Inc.

6725 Sunset Blvd. | 5th Floor | Los Angeles, CA 90028 | USA

www.native-instruments.com