

ARP ODYSSEY

DUOPHONIC SYNTHESIZER



Owner's Manual

Contents

| | |
|--|-----------|
| Introduction | 3 |
| What is the ODYSSEY?..... | 3 |
| Main Features..... | 3 |
| Block diagram..... | 4 |
| On-Screen Controls..... | 5 |
| Scale List | 8 |
| Available Parameters | 9 |
| Synth edit page | 9 |
| VOICES section..... | 10 |
| VCO-1 section..... | 11 |
| VCO-2 section..... | 12 |
| LFO, S/H MIXER, SAMPLE AND HOLD section..... | 13 |
| AUDIO MIXER, VCF, HPF, VCA section | 15 |
| ENVELOPE GENERATOR section | 17 |
| Arpeggiator/effect page..... | 19 |
| ARPEGGIATOR..... | 20 |
| Effects..... | 21 |
| MASTER LEVEL | 24 |

| | |
|-------------------------------------|-----------|
| Saving and Loading Data..... | 25 |
| Saving to internal memory..... | 25 |
| Loading from internal memory..... | 25 |
| Specifications | 26 |
| Support and service | 27 |

* Apple, iPad, iPhone, iPod touch, and iTunes are trademarks of Apple Inc., registered in the U.S. and other countries.
* All product names and company names are the trademarks or registered trademarks of their respective owners.

Introduction

Thank you for purchasing the ARP ODYSSEi. To fully enjoy your ARP ODYSSEi software synthesizer, please read this Owner's Manual carefully and keep it handy for future reference. Always use this product only as directed.

What is the ODYSSEY?

The ODYSSEY was manufactured from 1972 through 1981 by the ARP Corporation, and was one of their best-known products. Broadly speaking, there are three versions according to their date of production, and these three differ in appearance, as well as in tonal character and functionality.

Model 2800 is known as Rev. 1; this includes the initial white-panel model produced from 1972 to 1974 and the black-panel model produced from 1974 to about 1975.

Models 2810–2813 are known as Rev. 2; these consist of the black-panel models which were produced from 1975 to about 1976. Changes were made to the filter, and changes were also made to the oscillator of some models. External audio input and CV/GATE input jacks were also added, and later models changed the knob-style pitch bender to a PPC (Proportional Pitch Control).

Models 2820–2823 are known as Rev. 3, and were produced from 1978 to about 1981. The panel changed to a black panel with orange silk-screening, and the design also changed significantly from models 2800–2813. The audio output was also changed from RCA/PHONE to XLR/PHONE jacks.

Main Features

- ARP ODYSSEi reproduces the traditional VCO, VCF, and VCA of the ARP ODYSSEY. It allows flexible synthesis with a high degree of improvisatory freedom.
- Monophonic, duophonic, and polyphonic modes are provided. Duophonic mode sounds the oscillators at separate pitches when you play two keys simultaneously, and polyphonic mode lets you perform using the number of voices specified by the total voice parameter. (However, there is only a single filter and amp.)
- Two types of envelope generators are provided: ADSR type and AR type.
- Oscillator sync. This feature is valued for generating numerous high-frequency overtones and for its sharpness.
- Modulation can be applied in a wide variety of ways.
- Two types of noise are provided.
- LFO and S&H are provided, and you can switch their routing.
- The filters from the three different types of ARP ODYSSEY are provided, and can be selected by a single switch.
- The arpeggiator can be programmed in detail as on a step sequencer, and seven types of effects are newly provided to modify the sound in a variety of ways.
- MIDI clock can be received from an external sequencer to synchronize the tempo of the LFO or the arpeggiator.

Block diagram

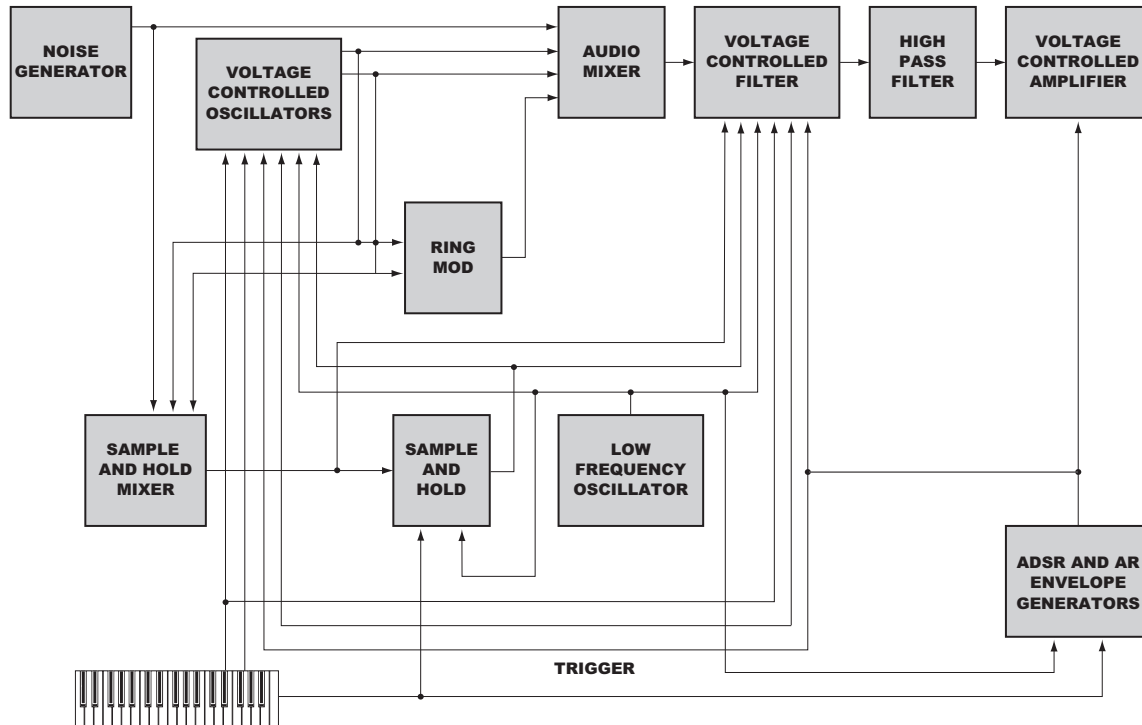

On-Screen Controls

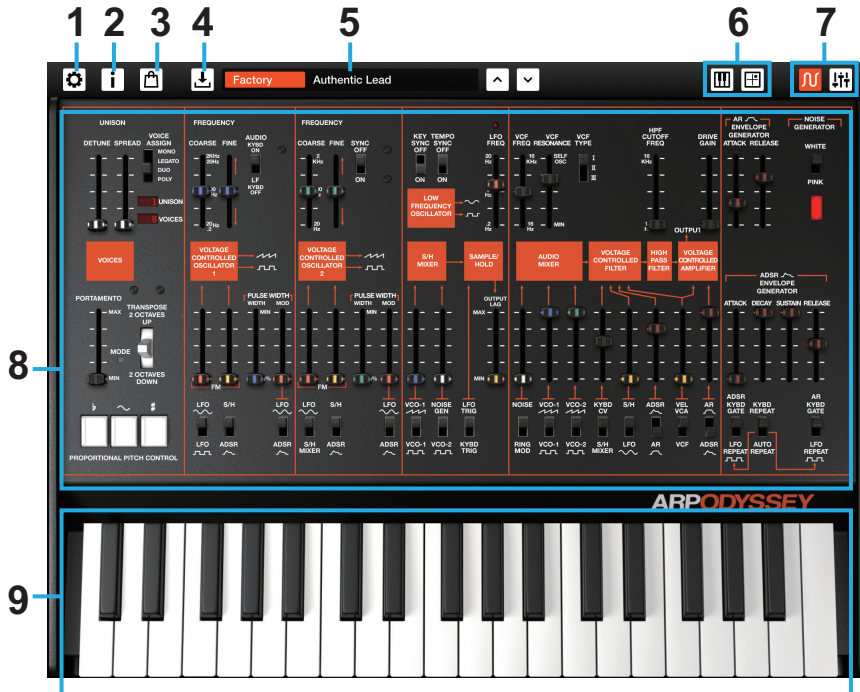

1. SETTINGS button

Here you can control settings such as Bluetooth MIDI, global MIDI channel, etc.

2. INFO button

Pressing the INFO button will display the version number of the ARP ODYSSEi for iPad, plus additional instructions on how to use it.

Manual: Displays the Owner's Manual.

FAQ: Displays the KORG App Help Center.

note You'll need an Internet connection in order to view the operating manual or the KORG App Help Center.

3. Store button

Displays a screen where you can purchase ARP ODYSSEY Rev.1 and Rev.2 skins and preset programs.

note In order to view the purchase screen, you must connect to the Internet.

4. FILE button

The FILE button is used to save and load ARP ODYSSEi for iPad file data (Refer to "Saving to internal memory" on page 25).

5. Program Name

This area of the screen displays the name of the currently selected Program. To switch to a different Program, simply tap the name (Refer to "Saving and Loading Data" on page 25).

6. Controller switches

These switches select either a keyboard with switchable octave and wheels, or a performance mode that uses XY pads.

: FULL SIZE Keyboard



BEND (Pitch Bend wheel)

The Bend wheel allows the performer to momentarily increase or decrease the overall pitch of the ARP ODYSSEi.

VIBRATO (Modulation wheel)

The MG wheel (Modulation Generator) is often used to add varying amounts of pitch modulation (Vibrato).

OCTAVE - button

Shifts the overall pitch of the keyboard down by one octave.

OCTAVE + button

Shifts the overall pitch of the keyboard up by one octave.

(CLOSE) button

Closes the full size keyboard.

: XY pads

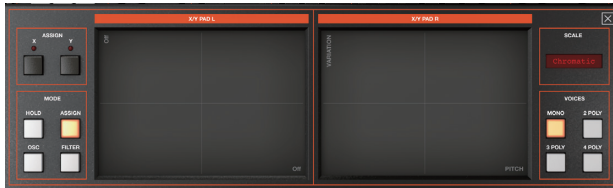

Drag across a pad to operate the parameters that are assigned to the X-axis (horizontal direction) and Y-axis (vertical direction). You can use this to play sounds or control parameters. For example, dragging horizontally on the right XY pad changes the pitch, and dragging vertically changes the note duration.

ASSIGN X button

Use this button to assign a parameter to the X-axis.

ASSIGN Y button

Use this button to assign a parameter to the Y-axis.

MODE..... [HOLD, ASSIGN, OSC, FILTER]

ASSIGN, OSC, FILTER: These buttons select which parameters will be controlled by XY Pad L.

HOLD: If this is on, the state controlled by the left-hand pad is maintained even after you release your finger.

XY Pad L

This Kaoss Pad will control the parameters that have been assigned to the X and Y axes.

Use the MODE button to choose the parameters that will be controlled.

XY Pad R

This Kaoss pad is dedicated to controlling the note. Dragging along the X-axis changes the pitch based on the the key and scale that are specified by using the SCALE button. Dragging along the Y-axis changes the inversion when playing chords. This feature has no effect if the VOICES parameter is set to Mono.

SCALE button

Tap here to specify the musical Key (root note) and Scale that will determine what notes are when using the Kaoss pad.

VOICES.....[MONO, 2POLY, 3POLY, 4POLY]

Use these buttons to choose the number of notes being played.

MONO: Only single notes are played.

2POLY: Two-note chords are produced; the chord inversion is controlled by the Y-Axis

3POLY: Three-note chords are produced; the chord inversion is controlled by the Y-Axis

4POLY: Four-note chords are produced; the chord inversion is controlled by the Y-Axis.

(CLOSE) button

Closes the XY Pad.

7. Page Select switches

These buttons switch between the synth edit page and the arpeggiator/effect page.

 : The synth edit page is displayed. (Refer to "Synth edit page" on page 9)

 : The arpeggiator/effect page is displayed. (Refer to "Arpeggiator/effect page" on page 19)

8. Editing area

Here you can edit the parameters that are shown in each edit page. Tap a controller or parameter to select it, and then edit its value.

9. Keyboard

Tap the keyboard to play notes. Drag the keyboard to play a glissando.

Scale List

| | Scale Name | Scale [Key C] |
|----|-------------|--|
| 1 | Chromatic | C, D ^b , D, E ^b , E, F, G ^b , G, A ^b , A, B ^b , B |
| 2 | Ionian | C, D, E, F, G, A, B |
| 3 | Dorian | C, D, E ^b , F, G, A, B ^b |
| 4 | Phrygian | C, D ^b , E ^b , F, G, Ab, B ^b |
| 5 | Lydian | C, D, E, G ^b , G, A, B |
| 6 | Mixolydian | C, D, E, F, G, A, B ^b |
| 7 | Aeolian | C, D, Eb, F, G, Ab, B ^b |
| 8 | Locrian | C, D ^b , E ^b , F, Gb, A ^b , B ^b |
| 9 | minor Harmo | C, D, E ^b , F, G, A ^b , B |
| 10 | minor Melod | C, D, E ^b , F, G, A, B |
| 11 | Major Blues | C, D, E ^b , E, G, A |
| 12 | minor Blues | C, E ^b , F, G ^b , G, B ^b |
| 13 | Diminish | C, D, E ^b , F, G ^b , A ^b , A, B |

| | Scale Name | Scale [Key C] |
|----|-------------|---|
| 14 | Com.Dim | C, D ^b , E ^b , E, G ^b , G, A, B ^b |
| 15 | Major Penta | C, D, E, G, A |
| 16 | minor Penta | C, E ^b , F, G, B ^b |
| 17 | Raga 1 | C, Db, E, F, G, A ^b , B |
| 18 | Raga 2 | C, D ^b , E, G ^b , G, A, B |
| 19 | Raga 3 | C, D ^b , E ^b , G ^b , G, A ^b , B |
| 20 | Arabic | C, D, E, F, G ^b , A ^b , Bb |
| 21 | Spanish | C, D ^b , E ^b , E, F, G, A ^b , B ^b |
| 22 | Gypsy | C, D, E ^b , G ^b , G, Ab, B |
| 23 | Egyptian | C, D, F, G, B ^b |
| 24 | Hawaiian | C, D, E ^b , G, A |
| 25 | Bali Pelog | C, D ^b , E ^b , G, A ^b |
| 26 | Japanese | C, D ^b , F, G, A ^b |
| 27 | Ryukyu | C, E, F, G, B |
| 28 | Chinese | C, E, G ^b , G, B |
| 29 | Bass Line | C, G, B ^b |
| 30 | Wholetone | C, D, E, G ^b , A ^b , B ^b |
| 31 | minor 3rd | C, E ^b , G ^b , A |
| 32 | Major 3rd | C, E, A ^b |
| 33 | 4th | C, F, B ^b |
| 34 | 5th | C, G |
| 35 | Octave | C |

Available Parameters

Synth edit page

The image displays a synthesizer's edit page for a patch named "Authentic Lead" in "Factory" mode. The interface is organized into several functional sections:

- UNISON:** Includes controls for Detune, Spread, Voice Assign (Mono, Legato, Duo, Poly), and a selection between 1 and 8 voices.
- FREQUENCY (Left):** Features Coarse and Fine frequency sliders (20Hz to 2KHz), a Voltage Controlled Oscillator 1 (VCO-1) with LFO and S/H controls, and a Portamento section with Transpose (2 Octaves Up/Down) and Mode (b, ~, #) buttons.
- FREQUENCY (Right):** Includes a second Voltage Controlled Oscillator 2 (VCO-2) with LFO and S/H controls, and a Key Sync section with Sync Off and On options.
- KEY/TEMPO SYNC:** Controls for Key Sync and Tempo Sync, both with On/Off options.
- OSCILLATORS & MIXERS:** A central section containing a Low Frequency Oscillator, S/H Mixer, Sample/Hold, and Audio Mixer.
- VCF & FILTERS:** Includes VCF Freq, Resonance, and Type (I, II, III) controls, along with a High Pass Filter and a Voltage Controlled Filter.
- ADSR & ENVELOPE:** Controls for Attack, Decay, Sustain, and Release, with options for LFO Repeat and Auto Repeat.
- OUTPUT & AMPLIFICATION:** Includes Drive Gain, a Voltage Controlled Amplifier, and a High Pass Filter.
- NOISE GENERATOR:** Provides White and Pink noise options with a level indicator.

Orange callouts and arrows highlight the signal flow from the oscillators through the mixers, filters, and amplifiers to the final output.

VOICES section



UNISON DETUNE slider [0.00...10.00]

Specifies the amount of detuning for the simultaneously-played voices if UNISON is set to a number greater than one and you are playing ARP ODYSSEi in unison mode. If UNISON is set to "1" (a single voice), this slider does nothing.

UNISON SPREAD slider [0.00...10.00]

Spreads the output of the voices between the L and R channels if UNISON is set to a number greater than one and you are playing ARP ODYSSEi in unison mode. If the UNISON setting is an odd number, one voice is panned to the center.

VOICE ASSIGN switch [MONO/LEGATO/ DUO / POLY]

Specifies how notes are produced.

MONO: Play monophonically.

LEGATO: Play monophonically. The EG is not retriggered by the second or subsequent keystroke if you continue holding down the previous key.

DUO: Play duophonically (two voices).

POLY: Play polyphonically.

UNISON (unison voice) [1...16]

Specifies the number of voices used when playing in unison mode. The maximum number of voices depends on the VOICES (total voice) setting.

Unison simultaneously sounds the number of voices that you specify here, with the output of VCO1 and VCO2 mixed.

VOICES (total voice) [1...32]

Specifies the maximum number of notes that can played if VOICE ASSIGN is set to "POLY" or when UNISON is used.

PORTAMENTO slider (black).....[MIN...MAX]

Specifies how the portamento effect is applied (the time over which the pitch change occurs).

If the slider is in the “MIN” position, no portamento effect is applied. As you move the slider toward the “MAX” position, the pitch change occurs over a longer time.

MODE switch[ON, OFF]

Selects whether portamento is enabled when you use the TRANSPOSE lever. Use a fine-tipped pen or similar object to press this switch.

TRANSPOSE lever [2 OCTAVES UP, 0, 2 OCTAVES DOWN]

Switches the range of pitches assigned to the keyboard in steps of two octaves.

PROPORTIONAL PITCH CONTROL -  Pad

The pitch is lowered according to how strongly you press the pad.

PROPORTIONAL PITCH CONTROL -  Pad

Vibrato is applied according to how strongly you press the pad.

PROPORTIONAL PITCH CONTROL -  Pad

The pitch is raised according to how strongly you press the pad.

VCO-1 section

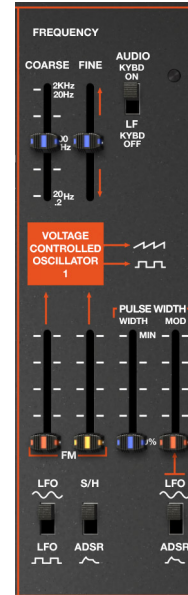

FREQUENCY COARSE slider (blue).....[20(0.2)Hz...2K(20)Hz]

Rough pitch adjustment.

This adjustment covers the range of 20 Hz–2 kHz if the keyboard switch is on, or 0.2 Hz–20 Hz if the keyboard switch is off.

 The frequency range (20 Hz–2 kHz) is an approximate value.

FREQUENCY FINE slider (blue) [±400cent]
Fine pitch adjustment.

Keyboard switch.....[AUDIO KYBD ON, LF KYBD OFF]

If this is set to AUDIO KYBD ON, VCO-1 is connected to the keyboard CV, and will produce pitches in the conventional way. If this is set to AUDIO KYBD OFF, VCO-1 is disconnected from the keyboard CV, and will oscillate as an LFO. You can use this signal to modulate VCO-2 or as an audio source for sound effects.

FM depth slider (pink)



FM depth slider (yellow)

Adjusts the depth of FM (Frequency Modulation) when it is applied.



PULSE WIDTH (WIDTH) slider (blue)[50%...MIN]
Adjusts the pulse width.

PULSE WIDTH (MOD) slider (pink)

Adjusts the depth of pulse width modulation.

FM source switch[LFO  , LFO ]
Selects the waveform of the modulation applied by the LFO.

FM source switch [S/H, ADSR ]
Selects either Sample and Hold or the envelope generator (ADSR) as the modulation source.

Pulse width modulation source switch[LFO  , ADSR ]
Selects the source that will apply pulse width modulation.

VCO-2 section

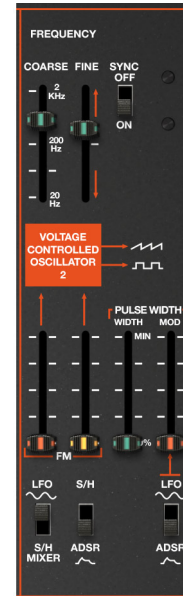

FREQUENCY COARSE slider (green).....[20(0.2)Hz...2K(20)Hz]
Rough pitch adjustment. This is adjustable in the range of 20 Hz – 2 kHz.

If the SYNC switch is on, this changes the overtone structure rather than the pitch.

 The frequency range (20 Hz–2 kHz) is an approximate value.

FREQUENCY FINE slider (green) [±400cent]

Fine pitch adjustment.

If the SYNC switch is on, this changes the overtone structure rather than the pitch.

SYNC switch..... [OFF, ON]

Turns sync on/off.

If this is off, duophonic performance is possible. If this is on, VCO-2 is synchronized with the frequency (pitch) of VCO-1.

FM depth slider (pink)

FM depth slider (yellow)

Adjusts the depth of FM (Frequency Modulation) when it is applied.

PULSE WIDTH (WIDTH) slider (blue) [50%...MIN]

Adjusts the pulse width.

PULSE WIDTH (MOD) slider (pink)

Adjusts the depth of pulse width modulation.

FM source switch [LFO , S/H MIXER]

Selects either modulation by an LFO sine wave or modulation by the S/H MIXER (sample and hold mixer).

FM source switch [S/H, ADSR ]

Selects either Sample and Hold or the envelope generator (ADSR) as the modulation source.

Pulse width modulation source switch [LFO , ADSR ]

Selects the source that will apply pulse width modulation.

LFO, S/H MIXER, SAMPLE AND HOLD section

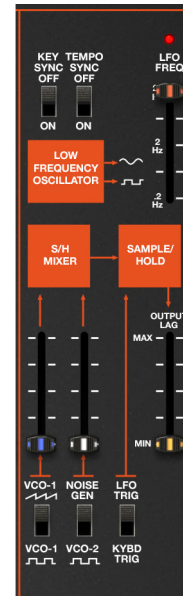

LFO KEY SYNC switch [OFF, ON]

If this is ON, the LFO starts each time you play a key, and an independent LFO operates for each note. If this is OFF, the LFO that was started by the first-played note is also applied to subsequently-played notes.

LFO TEMPO SYNC switch..... [OFF, ON]

Turn this on/off to specify whether the LFO is synchronized to the tempo (MIDI clock).

LFO FREQ (LFO speed) slider (pink) [0.2Hz...20Hz]

Adjusts the LFO speed.

Raising the slider makes the speed faster.

S/H input level slider (blue)

Adjusts the level at which the waveform output from VCO-1 is input to the S/H MIXER.

S/H input level slider (white)

Adjusts the level at which noise or the square wave output from VCO-2 is input to the S/H MIXER.

S/H OUTPUT LAG slider (yellow)

Smooths the changes of the S/H output voltage.

As you move the slider toward the "MAX" position, a greater amount of the smoothing will be applied.

S/H input source switch.....[VCO-1 , VCO-1 ]

Selects the source (VCO-1 waveform) that is input to the S/H MIXER.

S/H input source switch.....[NOISE GEN, VCO-2 ]

Selects the source (noise or VCO-2 square wave) that is input to the S/H MIXER.

S/H trigger source switch [LFO TRIG, KYBD TRIG]

Selects the signal (either the output of the LFO or the output of the keyboard) that is used as the trigger when detecting an audio signal sent from the S/H MIXER.

AUDIO MIXER, VCF, HPF, VCA section

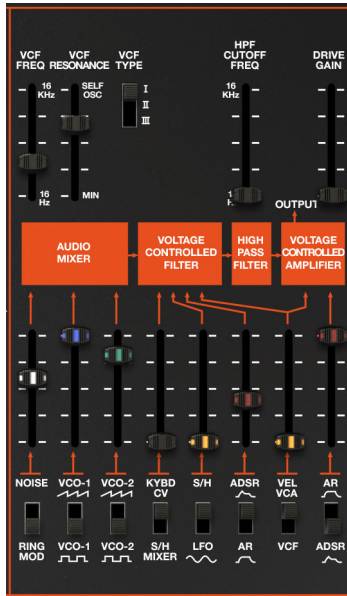

VCF FREQ slider (black)[16Hz...16KHz]

Adjusts how the LPF (Low Pass Filter) is applied. If the slider is in the lowest position (16 Hz), the high-frequency range of the input signal is cut, producing a soft sound. Raising the slider makes the sound brighter.

VCF RESONANCE slider (black) [MIN...SELF OSC]

Adjusts the resonance. This modifies the tonal character by boosting the overtones in the region of the cutoff point. As you raise the slider, self-oscillation (a state in which the VCF itself produces a sound) will occur starting at a certain point.

VCF TYPE switch [I, II, III]

Selects the type of VCF.

- I**: ODYSSEY Rev. 1
- II**: ODYSSEY Rev. 2
- III**: ODYSSEY Rev. 3

HPF CUTOFF FREQ slider (black)[16Hz...16KHz]

Adjusts how the HPF (High Pass Filter) is applied. As you raise the slider, the low-frequency region of the input signal is cut, producing a thinner sound. This is useful when you are simulating the sound of certain instruments.

DRIVE GAIN slider(white) [0.00...10.00]

Adjusts the amount of VCA distortion.

NOISE /RING MOD slider (white)

Adjusts the level of the audio signal that is sent from the noise generator or the ring modulator.

VCO-1 volume slider (blue)

Adjusts the level of the audio signal that is sent from VCO-1.

VCO-2 volume slider (green)

Adjusts the level of the audio signal that is sent from VCO-2.

Filter modulation level slider (black)

Adjusts the level of the signal that controls the VCF FREQ, or adjusts how the signal sent from the S/H MIXER opens and closes the filter.

Filter modulation level slider (yellow)

Adjusts how the filter is opened and closed by S/H (sample and hold) or the LFO.

Filter modulation level slider (pink)

Adjusts how the two envelope generators (AR and ADSR) control the filter.

VCA level slider (red)

Adjusts the level at which the envelope generators (AR and ADSR) control the VCA. In practical terms, this is the master volume of the ARP ODYSSEY.

If the DRIVE switch is on, this also adjusts the VCA distortion.

Filter input source (NOISE/RING MOD) switch[NOISE, RING MOD]

Selects either noise or ring modulator.

Filter input source (VCO-1 wave) switch

.....[VCO-1 , VCO-1 ]

Selects the VCO-1 waveform (sawtooth or square).

If you select square wave, you can raise the PULSE WIDTH slider (page 12) to change from a square wave to a pulse wave.

Filter input source (VCO-2 wave) switch

..... [VCO-2 , VCO-2 ]

Selects the VCO-2 waveform (sawtooth or square).

If you select square wave, you can raise the PULSE WIDTH slider (page 13) to change from a square wave to a pulse wave.

Filter modulation source (KYBD CV/S/H MIXER) switch

..... [KYBD CV, S/H MIXER]

Selects the source that will control the filter.

If you select KYBD CV (keyboard control voltage), the signal normally used to convey key information from the keyboard to the VCO can be used to open and close the filter. For example, you can produce an effect in which the filter opens more for higher notes.

If you select S/H MIXER, the signal sent from the S/H MIXER will open and close the filter.

Filter modulation source (S/H, LFO) switch[S/H, LFO]

Selects the source that will control the filter.

You can produce a wah effect by using the LFO to modulate the filter.

Filter modulation source (ADSR, AR) switch[ADSR , AR]

Selects the envelope generator that will control the filter.

VEL switch [VCA, VCF]

Specifies whether velocity will affect the depth of change for the VCA or VCF.

 This is used only if a MIDI keyboard is connected.

VCA EG switch.....[AR , ADSR]

Selects the envelope generator that will control the VCA.

ENVELOPE GENERATOR section

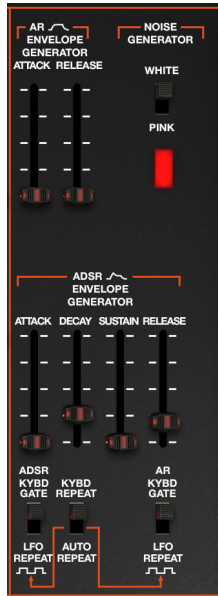

AR EG - ATTACK slider (red)

Adjusts the attack time of the AR envelope generator.

AR EG - RELEASE slider (red)

Adjusts the release time of the AR envelope generator.

NOISE GENERATOR switch [WHITE, PINK]

Selects white noise or pink noise.

ADSR EG - ATTACK slider (red)

Adjusts the attack time of the ADSR envelope generator.

ADSR EG - DECAY slider (red)

Adjusts the decay time of the ADSR envelope generator.

ADSR EG - SUSTAIN slider (red)

Adjusts the sustain time of the ADSR envelope generator.

ADSR EG - RELEASE slider (red)

Adjusts the release time of the ADSR envelope generator.

ADSR trigger source switch [KYBD GATE, LFO REPEAT]

Selects the trigger that is sent to the ADSR envelope generator.

If KYBD GATE is selected, the trigger sent from the keyboard is sent to the EG. If LFO REPEAT is selected, the pulse wave of the LFO is sent to the EG, and the EG repeats the envelope cyclically at the rate of the LFO FREQ.

ADSR repeat switch [KYBD REPEAT, AUTO REPEAT]

This is effective if LFO REPEAT is selected by the ADSR or by the AR trigger source switch.

If KYBD REPEAT is selected, the LFO trigger sent repeatedly to the EG continues repeating only as long as the key is pressed. If AUTO

REPEAT is selected, it continues repeating regardless of the keyboard on/off status.

AR trigger source switch[KYBD GATE, LFO REPEAT]

Selects the trigger that is sent to the AR envelope generator.

This has the same function as the ADSR trigger switch.

Arpeggiator/effect page

The interface is divided into two main sections: the Arpeggiator and the Effects section.

Arpeggiator Section:

- Tempo:** Mode (RND, THREE, EVEN, ODD, BKWD, FWD), Sync (OFF/ON), Freq (knob), Steps (knob, 1-16).
- Type:** Chord (OFF/ON), ARP (OFF/ON).
- Note:** SEMITONE (OFF/ON), OCTAVE (OFF/ON), GATE (OFF/ON).
- Parameter:** D12 (three instances, OFF/ON).
- GLIDE:** A vertical slider.
- Arpeggiator Pattern:** A 16-step sequencer with 16 vertical sliders and colored buttons (1-16).

Effects Section:

- DISTORTION:** Type (I, II, III), Drive, Tone, Mix, Latch (OFF/ON).
- PHASER:** Manual, Depth, Freq, Resonance, Latch (OFF/ON).
- CHORUS FLANGER ENSEMBLE:** Type (CHO, FLA, ENS), Depth, Freq, Mix, Latch (OFF/ON).
- EQ:** LO GAIN (15 dB), MID FREQ (4 KHz), MID GAIN (15 dB), HI GAIN (15 dB), Latch (OFF/ON).
- DELAY:** Tempo Sync (OFF/ON), Feed Back, Time Left, Time Right, Level, Latch (OFF/ON).
- REVERB:** Type (HALL, ROOM, PLATE, APOLLO), Time, Tone, Mix, Latch (OFF/ON).
- MASTER:** Level knob.

ARPEGGIATOR

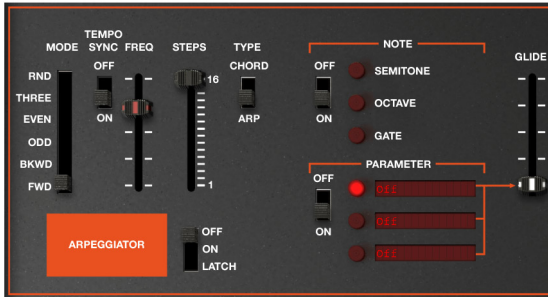

MODE switch

Specifies how steps advance when the arpeggiator plays.

RND: Steps are played randomly.

THREE: Every third step is played.

EVEN: Even-numbered steps are played.

ODD: Odd-numbered steps are played.

BKWD: Advance from right to left.

FWD: Advance from left to right.

TEMPO SYNC switch

Turn this on/off to specify whether the LFO is synchronized to tempo (MIDI clock).

FREQ slider [0...127, 1/8...1/64]

Specifies the playback speed.

If the TEMPO SYNC switch is ON, this slider specifies the interval of the tempo that is synchronized to MIDI clock.

STEPS slider [1...16]

Specifies the number of steps to loop.

TYPE switch [CHORD, ARP]

Specifies whether each step will play single notes or chords.

CHORD: The notes of multiple keys that you press are sounded as a chord at each step.

ARP: The keys that you press are sounded as an arpeggio.

ARPEGGIATOR switch [OFF, ON, LATCH]

Switches the arpeggiator on/off.

If you select LATCH, the arpeggiator continues playing even after note-off.

NOTE switch

Switches to the channel that will control the pitch or some other aspect of the sound.

SEMITONE: Controls the pitch.

OCTAVE: Controls the pitch in one-octave units.

GATE: Controls the duration of notes.

PARAMETER switch

Assigns parameters to three channels to control the selected parameter.

GLIDE slider

Specifies the transition time for the effect assigned by the PARAMETER switch.

Effects

DISTORTION

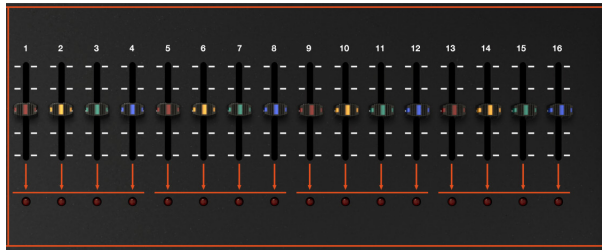

Step sliders 1–16[1...16]
Specify the value of each step.



This is a distortion effect that lets you choose from three types of distortion.

TYPE switch

Selects the effect type.

DRIVE slider (blue)

Adjusts the amount of distortion by adjusting the input level of the distortion circuit.

TONE slider (yellow)

Adjusts the tone.

MIX slider (red)

Adjusts the balance between the effect sound and direct sound.

ON/OFF switch

To use this effect, turn this ON.

PHASER



This effect modulates the sound by combining the original sound with a sound whose phase changes periodically.

MANUAL slider (white)

Adjusts the frequency at which the effect is applied.

DEPTH slider (yellow)

Adjusts the depth of the effect.

FREQ slider (green)

Adjusts the speed of modulation.

RESONANCE slider (red)

Adjusts the amount of resonance.

ON/OFF switch

To use this effect, turn this ON.

CHORUS/FLANGER/ENSEMBLE

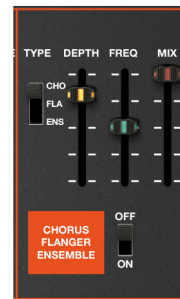

This effect gives the sound spaciousness and a sense of vibrato by combining the original sound with a signal whose pitch is modulated.

TYPE switch

Selects the effect type.

DEPTH slider (yellow)

Adjusts the depth of the effect.

FREQ slider (green)

Adjusts the speed of modulation.

MIX slider (red)

Adjusts the balance between the effect sound and direct sound.

ON/OFF switch

To use this effect, turn this ON.

EQ

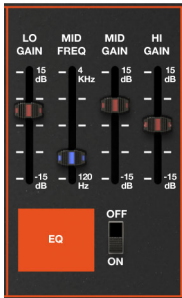

This boosts or cuts the levels of the low, mid, and high-frequency region.

LO GAIN slider (red)

Adjusts the low-frequency region.

MID FREQ slider (blue)

Specifies the frequency of the mid-frequency region.

MID GAIN slider (red)

Adjusts the mid-frequency region.

HI GAIN slider (red)

Adjusts the high-frequency region.

ON/OFF switch

To use this effect, turn this ON.

DELAY

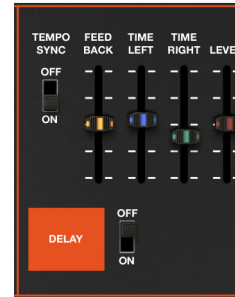

This effect delays the sound in time.

TEMPO SYNC switch

Turn this on/off to specify whether the delay time is synchronized to tempo.

FEED BACK slider (yellow)

Adjusts the amount of feedback.

TIME LEFT slider (blue)

Adjusts the delay time of the left channel.

TIME RIGHT slider (green)

Adjusts the delay time of the right channel.

LEVEL slider (red)

Adjusts the level of the effect sound.

ON/OFF switch

To use this effect, turn this ON.

REVERB



This effect simulates reverberation and acoustic space.

TIME slider (green)

Adjusts the reverb time.

TONE slider (yellow)

Adjusts the brightness of the reverb sound.

MIX slider (red)

Adjusts the balance between the effect sound and direct sound.

ON/OFF switch

To use this effect, turn this ON.

MASTER LEVEL

MASTER



This is the master volume slider; use this to set the output level.

LEVEL slider (red)

Adjusts the output level.

Saving and Loading Data

Saving to internal memory

You can save an edited program to the internal memory of ARP ODYSSEI.

 An edited program will be lost if you exit the application without saving. If you want to keep the program, you must save it.

Tap the program name, and select a command in the window that appears.

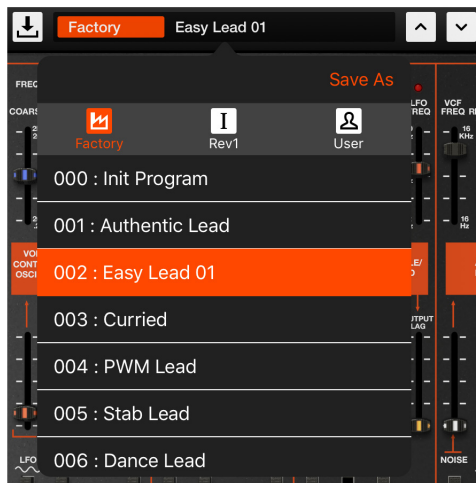

Folder: Selects a folder.

If you purchased the Rev.1 or Rev.2 skin, or preset programs, from the store, the panel skin will change when you select the appropriate folder here and then select a program.

Program list: Shows the programs inside the selected folder.

Save: Overwrite-saves the program.

Save As: Saves the program with a different name. A new program is created with the name that you enter.

Loading from internal memory

Tap the program name, and in the program list in the window that appears, tap the program that you want to load.

Specifications

ARP ODYSSEI

- **Maximum polyphony:** 8 notes (depends on the model of iPad)
- **Number of parts:** 1
- **Sounds:**
Presets: more than 250 (Including in-app billing content)
- **Effects:** 6 types

* Appearance and specifications of this product are subject to change without notice.

Support and service

If you have questions about the product, please contact the Korg distributor for the country in which you purchased it.

Information to provide when contacting us

In order for us to help you, we'll need the following information since product support cannot be provided without it

- Your name
- The name and version of the product (How to check the version)
- The name of the device that you're using
- The version of the operating system
- Your question (provide as much detail as possible)

Before you contact us

- Before you contact us, check whether this manual or KORG app Help Center has an answer for your question.
- Please be aware that we cannot answer questions about products that are not made by Korg, such as basic operation of your hardware device, or general questions about creating songs or sounds.

KORG INC.

4015-2 Yanokuchi, Inagi-City, Tokyo 206-0812 JAPAN

© 2016 KORG INC.